

SVENSKA  
ENGLISH  
DEUTSCH  
ESPAÑOL  
FRANÇAIS  
SUOMI  
NORSK  
DANSK  
NEDERLANDS

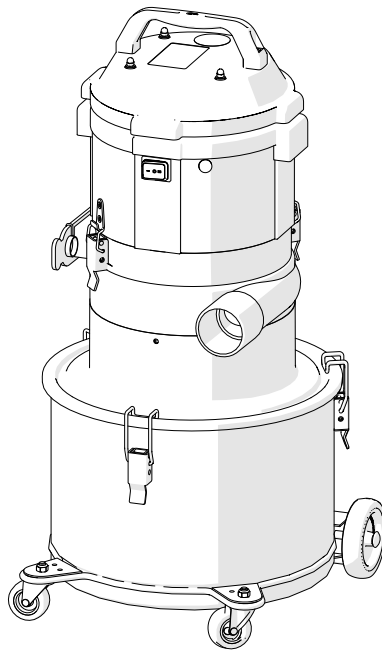

# DC 1800 H, DC 1800 H Auto, DC 1800 XL

---



# Innehållsförteckning

DC 1800 H, DC 1800 H Auto, DC 1800 XL .....	8
Rättsligt meddelande .....	8
Säkerhetsföreskrifter .....	9
Intro .....	9
Varning .....	9
Miljöskydd .....	9
WEEE (Waste of Electric and Electronic Equipment) .....	10
Arbetsmiljö .....	10
Överbelastning .....	10
Kroppskador .....	10
Elkabel .....	11
Viktig åtgärd .....	11
Omsorg .....	11
Kontroll .....	11
Funktionsbeskrivning .....	12
Tekniska data .....	13
Drift .....	14
Anslut .....	14
Autostart .....	14
Filterrensning .....	14
Tömning .....	14
Service & underhåll .....	15
Rengöring .....	15
Filterbyte .....	15
Motor .....	15
Regelbunden kontroll .....	15
Förbrukningsartiklar & tillbehör .....	16
Garanti .....	17
Motor .....	17
Felsökning .....	18
EG-försäkran .....	19
Reservdelar .....	20
Kontakt .....	21
DC 1800 H, DC 1800 H Auto, DC 1800 XL .....	22
Legal notice .....	22
Safety regulations .....	23
Intro .....	23
Warning .....	23
Environmental protection .....	23
WEEE (Waste of Electric and Electronic Equipment) .....	24
Work environment .....	24
Overload .....	24
Bodily injuries .....	24
Electric cable .....	25
Important action .....	25
Care .....	25
Control .....	25
Functional Description .....	26
Technical data .....	27
Operation .....	28
Connection .....	28
Autostart .....	28
Filter cleaning: .....	28
Emptying .....	28
Service & maintenance .....	29
Cleaning .....	29
Filter replacement .....	29
Engine .....	29
Regular check .....	29

Consumables & accessories .....	30
Warranty .....	31
Engine .....	31
Troubleshooting .....	32
EC Declaration of Conformity .....	33
Spare parts .....	34
Contact .....	35
DC 1800 H, DC 1800 H Auto, DC 1800 XL .....	36
Rechtlicher Hinweis .....	36
Sicherheitsvorschriften .....	37
Einführung .....	37
Warnung .....	37
Umweltschutz .....	37
WEEE (Abfall von Elektro- und Elektronik- Altgeräte) .....	38
Arbeitsumfeld .....	38
Überlast .....	38
Körperverletzungen .....	38
Stromkabel .....	39
Wichtige Aktion .....	39
Pflege .....	39
Kontrolle .....	39
Funktionsbeschreibung .....	40
Technische Daten .....	41
Betrieb .....	42
Anschließen .....	42
Autostart .....	42
Filterreinigung .....	42
Leeren .....	42
Service & Wartung .....	44
Reinigung .....	44
Filterwechsel .....	44
Motor .....	44
Regelmäßige Kontrolle .....	44
Verbrauchsmaterialien und Zubehör .....	45
Gewährleistung .....	46
Motor .....	46
Fehlersuche und -behebung .....	47
EG-Konformitätserklärung .....	48
Ersatzteile .....	49
Kontakt .....	50
DC 1800 H, DC 1800 H Auto, DC 1800 XL .....	51
Aviso legal .....	51
Normas de seguridad .....	52
Introducción .....	52
Advertencia .....	52
Protección ambiental .....	52
RAEE (Residuos de aparatos eléctricos y electrónicos) .....	53
Ambiente de trabajo .....	53
Sobrecarga .....	53
Lesiones corporales .....	53
cable electrico .....	54
Acción importante .....	54
Cuidado .....	54
Control .....	54
Descripción de las funciones .....	55
Datos técnicos .....	56
Operación .....	57
Conexión .....	57
Autoarranque .....	57
Limpieza de los filtros .....	57
Vacío .....	57
Servicio y mantenimiento .....	59

Limpieza .....	59
Reemplazo de filtro .....	59
Motor .....	59
Control periódico .....	59
Consumibles y accesorios .....	60
Garantía .....	61
Motor .....	61
Detección y resolución de problemas .....	62
Declaración de conformidad para el mercado CE .....	63
Piezas de repuesto .....	64
Contacto .....	65
DC 1800 H, DC 1800 H Auto, DC 1800 XL .....	66
Mentions légales .....	66
Règles de sécurité .....	67
Introduction .....	67
Avertissement .....	67
Protection de l'environnement .....	67
DEEE (Déchets d'équipements électriques et électroniques) .....	68
Environnement de travail .....	68
Surcharge .....	68
Blessures corporelles .....	68
Câble électrique .....	69
Action importante .....	69
Soins .....	69
Contrôle .....	69
Description fonctionnelle .....	70
Données techniques .....	71
Opération .....	72
Branchement .....	72
Démarrage automatique .....	72
Nettoyage du filtre .....	72
Vidange .....	72
Service et entretien .....	73
Nettoyage .....	73
Remplacement du filtre .....	73
Moteur .....	73
Contrôle régulier .....	73
Consommables & accessoires .....	74
Garantie .....	75
Moteur .....	75
Recherche de pannes .....	76
Déclaration CE .....	77
Des pièces de rechange .....	78
Contact .....	79
DC 1800 H, DC 1800 H Auto, DC 1800 XL .....	80
Oikeudellinen huomautus .....	80
Turvallisuusmääräykset .....	81
Johdanto .....	81
Varoitus .....	81
Ympäristönsuojelu .....	81
WEEE (Waste of Electric and Electronic Equipment) .....	82
Työympäristö .....	82
Ylikuormitus .....	82
Ruumiinvammat .....	82
Sähkökaapeli .....	83
Tärkeä toimenpide .....	83
Hoito .....	83
Ohjaus .....	83
Toimintakuvaus .....	84
Tekniset tiedot .....	85
Toiminta .....	86
Kytkeminen .....	86

Automaattinen käynnistys .....	86
Suodattimen puhdistus .....	86
Tyhjennys .....	86
Huolto & huolto .....	87
Puhdistus .....	87
Suodattimen vaihto .....	87
Moottori .....	87
Säännöllinen tarkastus .....	87
Kulutustarvikkeet ja tarvikkeet .....	88
Takuu .....	89
Moottori .....	89
Vianmääritys .....	90
EY-vaatimustenmukaisuusvakuutus .....	91
Varaosat .....	92
Ota yhteyttä .....	93
DC 1800 H, DC 1800 H Auto, DC 1800 XL .....	94
Juridisk varsel .....	94
Sikkerhetsforskrifter .....	95
Intro .....	95
Advarsel .....	95
Miljøvern .....	95
WEEE (Waste of Electric and Electronic Equipment) .....	96
Arbeidsmiljø .....	96
Overbelastning .....	96
Kroppsskader .....	96
Elektrisk kabel .....	97
Viktig handling .....	97
Omsorg .....	97
Kontroll .....	97
Funksjonsbeskrivelse .....	98
Tekniske data .....	99
Operasjon .....	100
Tilkobling .....	100
Autostart .....	100
Filterrensing .....	100
Tømming .....	100
Service og vedlikehold .....	101
Rengjøring .....	101
Filterbytte .....	101
Motor .....	101
Regelmessig sjekk .....	101
Forbruksvarer og tilbehør .....	102
Garanti .....	103
Motor .....	103
Feilsøking .....	104
EU-erklæring .....	105
Reservedeler .....	106
Kontakt .....	107
DC 1800 H, DC 1800 H Auto, DC 1800 XL .....	108
Juridisk meddelelse .....	108
Sikkerhedsbestemmelser .....	109
Intro .....	109
Advarsel .....	109
Miljøbeskyttelse .....	109
WEEE (Waste of Electric and Electronic Equipment) .....	110
Arbejds miljø .....	110
Overbelaste .....	110
Kropsskader .....	110
Elektrisk kabel .....	111
Vigtig handling .....	111
Omsorg .....	111
Kontrollere .....	111

Funktionsbeskrivelse .....	112
Teknisk data .....	113
Operation .....	114
Tilslutning .....	114
Autostart .....	114
Filterrensning .....	114
Tømning .....	114
Service & vedligeholdelse .....	115
Rengøring .....	115
Udskiftning af filter .....	115
Motor .....	115
Regelmæssig kontrol .....	115
Forbrugsvarer og tilbehør .....	116
Garanti .....	117
Motor .....	117
Fejlfinding .....	118
EF-overensstemmelseserklæring .....	119
Reserve dele .....	120
Kontakte .....	121
DC 1800 H, DC 1800 H Auto, DC 1800 XL .....	122
Juridische mededeling .....	122
Veiligheidsvoorschriften .....	123
Intro .....	123
Waarschuwing .....	123
Milieubescherming .....	123
WEEE (Waste of Electric and Electronic Equipment), ofwel AEEA: Afval van elektrische en elektronische apparatuur .....	124
Werkomgeving .....	124
Overbelasting .....	124
Lichamelijke verwondingen .....	124
Elektrische kabel .....	125
Belangrijke actie .....	125
Zorg .....	125
Controle .....	125
Beschrijving van de werking .....	126
Technische gegevens .....	127
Operatie .....	128
Aansluiting .....	128
Auto-start .....	128
Reinigen van het filter .....	128
Legen .....	128
Service & onderhoud .....	130
Schoonmaken .....	130
Filtervervanging .....	130
Motor .....	130
Regelmatige controle .....	130
Verbruiksartikelen en accessoires .....	131
Garantie .....	132
Motor .....	132
Probleemoplossing .....	133
EG-verklaring .....	134
Reserveonderdelen .....	135
Contact .....	136

## Rättsligt meddelande



### **OBS!**

Bruksanvisning i original



### **VIKTIGT**

Läs bruksanvisningen före användning av maskinen.



### **VIKTIGT**

Dustcontrol förbehåller sig rätten att ändra specifikationer utan förvarning och är inte skyldig att ändra tidigare levererade produkter. Dustcontrol ansvarar inte för fel eller utelämnanden i denna bruksanvisning.



### **VIKTIGT**

Alla relevanta statliga, regionala och lokala säkerhetsföreskrifter måste följas vid installation och användning av denna produkt. Av säkerhetsskäl och för att säkerställa överensstämmelse med dokumenterade systemdata ska endast tillverkaren utföra reparationer av komponenter. Underlåtenhet att följa denna information kan leda till personskador eller skador på utrustningen.



### **VIKTIGT**

Alla rättigheter förbehållna. Ingen del av denna publikation får reproduceras, distribueras eller överföras i någon form eller på något sätt, inklusive fotokopiering, inspelning eller andra elektroniska eller mekaniska metoder, utan föregående skriftligt tillstånd från utgivaren. För tillståndsförfrågningar, kontakta Dustcontrol.



### **OBS!**

Produkten tillverkas av:

Dustcontrol AB  
Box 3088, Kumla Gårdsväg 14  
SE-145 03 Norsborg  
Tel: +46 8 531 940 00  
support@dustcontrol.se  
www.dustcontrol.com



# Säkerhetsföreskrifter

## Intro

Läs följande säkerhetsföreskrift innan du startar denna maskin. Spara bruksanvisningen. Om inte säkerhetsföreskriften följs gäller inte garanti. Person- och produktskada kan även uppstå. Dustcontrol ansvarar ej för skador på utrustningen som uppkommit på grund av felaktig installation eller felaktigt handhavande av utrustningen.

## Varning

Denna maskin är endast avsedd för professionellt bruk.

Barn skall övervakas för att säkerställa att de inte leker med maskinen.

Använd endast originaltillbehör och förbrukningsartiklar som ingår i Dustcontrols sortiment.



### **VARNING**

Använd maskinen för avsett ändamål. Följ föreskrifterna för det material som sugs.



### **VARNING**

Denna maskin är endast avsedd för uppsugning av torrt material.



### **VARNING**

Vid användandet av elektriska enheter ska grundläggande säkerhetsföreskrifter följas för att minska risken för brand, elstöt eller personskada.



### **VARNING**

Inga heta, glödande partiklar eller andra antändningskällor får sugas in i maskinen. Maskinen ska ej användas för explosiva, instabila eller självantändliga partiklar.



### **VARNING**

Endast Dustcontrols filter får användas. Om andra filter används hävs garantin. Vid användande av undermåliga filter finns risk för person eller produktskada.

## Miljöskydd

Återvinn emballage och ingående komponenter enligt lokala föreskrifter. För mer information kontakta er närmaste återvinningscentral eller Dustcontrol för skrotning av maskin.

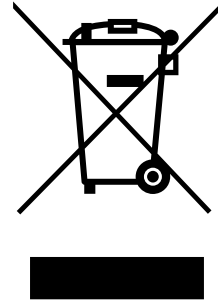
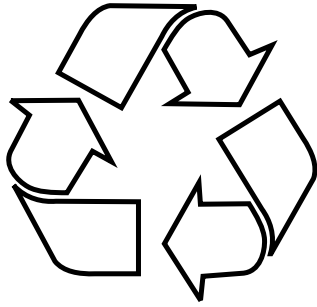

### WEEE (Waste of Electric and Electronic Equipment)

Gäller endast EU-länder: Elektriska verktyg får inte kastas i hushållssoporna. Enligt direktivet 2002/96/EG som avser äldre elektrisk och elektronisk utrustning och dess tillämpning enligt nationell lagstiftning ska uttjänta elektriska verktyg sorteras separat och lämnas till miljövänlig återvinning.

### Arbetsmiljö

Utsätt inte maskinen för väta. Använd den ej i fuktiga och våta utrymmen eller i närheten av lättantändliga vätskor eller gaser.



#### OBSERVERA

Denna maskin får endast användas och förvaras i torr miljö.



#### OBSERVERA

Maskinen får ej sköljas med vatten.

### Överbelastning



#### OBSERVERA

Låt aldrig maskinen arbeta helt strypt eftersom detta innebär en risk för överhettning.

### Kroppskador



#### VARNING

Försök aldrig att på egen hand ändra elektriska kopplingar. Ett fel kan medföra livsfara!



#### VARNING

Låt aldrig sugpunkten komma i kontakt med någon kroppsdel. Det starka undertrycket kan skada hudens blodkärl.



### **VARNING**

Vid montering, hantering och transport av produkten ska skyddshandskar användas.

## **Elkabel**



### **VARNING**

Dra aldrig maskinen med hjälp av elkabeln. Utsätt inte elkabeln för värme eller skarpa föremål. Kontrollera elkabeln regelbundet.

Vid koppling av elkabel till skarvsladd måste skarvsladden vara vattenskyddad (IP44).

Maskinen får inte användas om elkablarna eller kontakterna är skadade.

Om elkabeln är skadad måste den bytas av Dustcontrol eller av Dustcontrol auktoriserad serviceverkstad.

### **Viktig åtgärd**

Stäng av huvudströmbrytaren och koppla bort maskinen från elnätet innan du rengör eller utför underhåll på maskinen.

Denna maskin får endast användas om alla filter är oskadade och rätt monterade.

### **Omsorg**

Håll maskinen ren och fri från stoftavlagringar. Se till att sugslangen är hel och att alla tätningar är intakta och felfria. Håll bärhandtagen torra och fria från olja och fett.

### **Kontroll**

Kontrollera regelbundet att enheten inte har skador eller förslitningar. Uppstår skador ska dessa åtgärdas av Dustcontrols servicetekniker eller av en Dustcontrol auktoriserad serviceverkstad.

## Funktionsbeskrivning

Stoftavskiljaren arbetar med undertryck (sug) som driver luften genom sugkåpa/munstycke, slangsystem samt för- och stoftavskiljare. Grovavskiljning sker i enhetens cyklon, vilket är en mycket effektiv avskiljning av allt grövre damm. Findammet avskiljes i enhetens filter. Filterrensning med luftpuls ger filtren extra lång livslängd. Maskinen är utrustad med HEPA-filter.

Stoftavskiljaren är driftsäker och oöm. Den är speciellt lämpad för uppsugning och avlägsnande av torrt, hälsofarligt, icke-brännbart stoft i klass H samt stoft med ELV och stoft av cancerframkallande ämnen enligt GefStoffV (German Hazardous Substances Ordinance).

<b>H</b>	<p><b>WARNING:</b> This machine contains dust hazardous to health. Emptying and maintenance operations, including removal of the dust collection means, must only be carried out by authorised personnel wearing suitable personal protection. Do not operate without the full filtration system fitted.</p>	<p><b>ACHTUNG:</b> Dieses Gerät enthält gesundheitsschädlichen Staub. Leerungs- und Wartungsvorgänge, einschließlich der Beseitigung der Staubsammelbehälter, dürfen nur von Fachleuten durchgeführt werden, die entsprechende Schutzausrüstung tragen. Nicht ohne das vollständige Filtrationssystem betreiben.</p>	<p><b>VARNING:</b> Denna utrustning innehåller hälsofarligt damm. Tömning och service, inklusive filterbyte, får endast utföras av en fackman med lämplig personlig skyddsutrustning. Får ej användas utan komplett filtersystem.</p>	<b>H</b>
----------	--	--	---	----------

## Tekniska data

Tekniska data	DC 1800H	DC 1800H XL
HxBxD [mm]	780 x 405 x 390	1225 x 402 x 382
Vikt [kg]	14	19
Inlopp [mm]	Ø50	Ø50
Slanglängd Ø38 [m]	5	5
Uppsamlingsbehållare [l]	20	55
Flöde max [m <sup>3</sup> /h]	205	205
Undertryck max [kPa]	24	24
Effektuttag [W]	1285 (230 V)	1285 (230 V)
Auto: Effekt anslutet verktyg*/min 200W	115/230 V/ 10A: 1340/1285 W 230 V/16 A: 2200 W	115/230 V/10 A: 1340/1285 W 230 V/16 A: 2200 W
Finfilter cellulosa, area [m <sup>2</sup> ]	1,5	1,5
Avskiljningsgrad finfilter, EN 60335-2-69, Klass M [%]	99,9	99,9
Filteryta HEPA-filter [m <sup>2</sup> ]	0,85	0,85
Avskiljningsgrad maskinen, EN 60335-2-69, Bilaga A-A, Klass H [%]	99,995	99,995
Filterklassificering, EN 1822-1	HEPA H13	HEPA H13
Ljudnivå [dB(A)]	< 66	< 68
IP	44	44

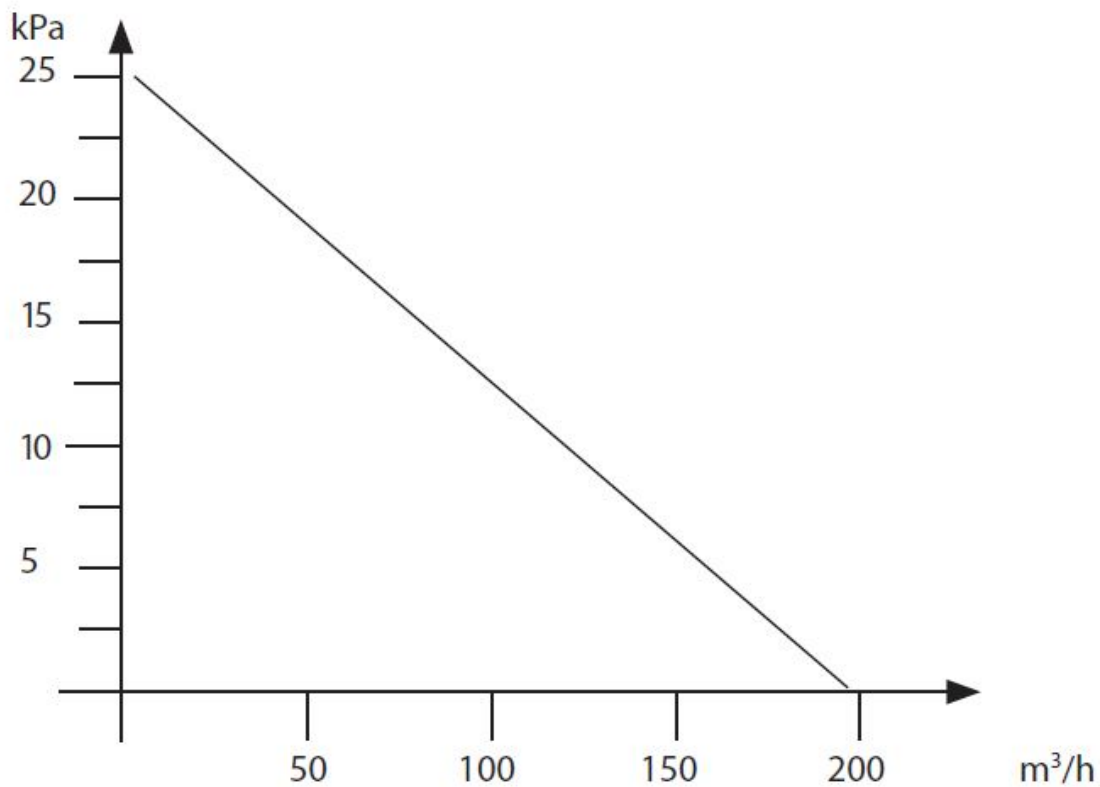

Tryckalstring och luftflöde

## Drift

### Anslut

Anslut maskinen till ett eluttag med spänning enligt specifikationerna på maskinens märkplåt.

### Autostart

Anslut elektriskt verktyg till uttaget på maskinen. Ställ omkopplaren i läge AUTO. Maskinen startar sedan automatiskt när verktyget startas. Maskinen stängs av ett par sekunder efter att det tillkopplade verktyget stängs. För manuell start av suget, sätt omkopplaren i läge MAN.

### Filterrensning

Maskinen har en filterindikationslampa som lyser när filtret behöver rensas eller bytas.

Så här rengör du filtret:

Vid filterrensning ska maskinen vara igång och slangen lossas från sugröret.

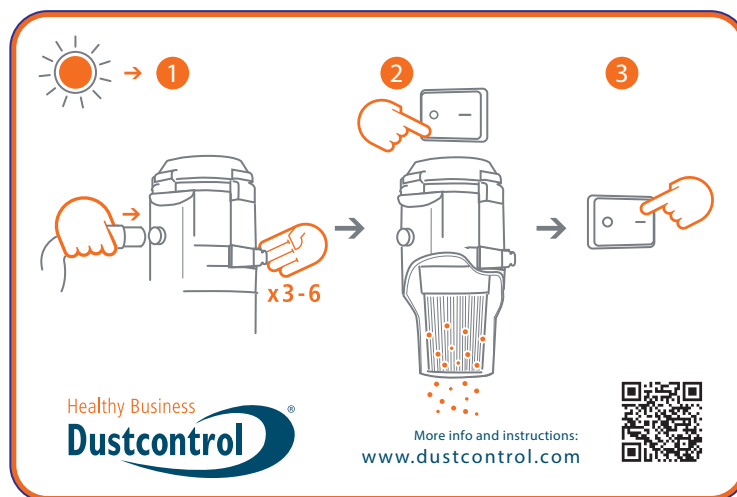

1. Tryck anslutningsmuffen mot den svarta stopplacken på utluftskanalen eller mot golvet, så att maximalt undertryck skapas i cyklonen. Öppna därefter luckan på sidan 3-6 gånger. Luften strömmar in i maskinen och rensar filtret med pulsverkan.
2. Stäng av maskinen och låt materialet falla ner. Återanslut sugröret.
3. Starta maskinen.

### Tömning

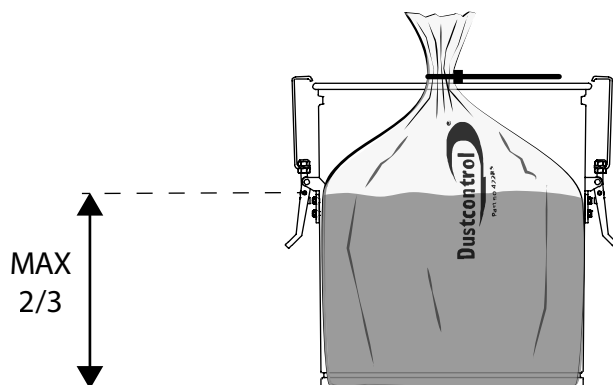

Behållaren under cyklonen bör tömmas när den är fylld till max 2/3.

## Service & underhåll

### Rengöring

Vid rengöring och skötsel av maskinen ska maskinen vara avstängd och kontakten dras ur.

### Filterbyte

Finfiltret ska bytas minst en gång per år. HEPA-filtret ska bytas efter 300 driftstimmar. Endast original-filter får användas.



#### **VARNING**

Filterbyte får endast utföras av instruerad personal. Använd skyddsmask och lämplig utrustning.

1. Lossa och lyft av locket för att få fri åtkomst till filtret. Trä därefter en plastsäck över cyklonen.
2. Lyft filtret rakt upp in i plastsäcken. Kontrollera därefter att packningen är hel. Vid skada så måste packningen bytas ut för att säkerställa tätheten.
3. Knyt ihop säcken runt filtret.
4. Kassera filtret och plastsäcken på rätt sätt.

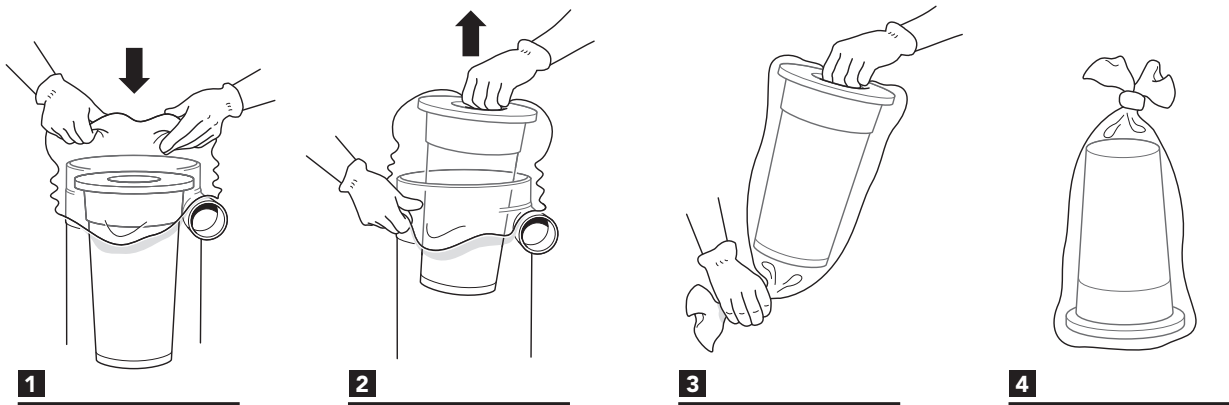

### Motor

För fläktmotorer är den typiska livslängden för originalborstar 600-700 timmar. Borsten kan bytas. För det andra borstpaketet är livslängden ca 400 timmar och för det tredje borstpaketet ca 300 timmar. Efter detta är kollektorn utsliten och motorn behöver bytas.

### Regelbunden kontroll

Kontrollera regelbundet att elkabeln inte är skadad.

## Förbrukningsartiklar & tillbehör

Benämning	Art nr
Plastsäck, standard	42291
Plastsäck (XL)	42285
Finfilter cellulosa, med integrerat filterskydd	42029
Finfilter PTFE, med integrerat filterskydd	42028-02
HEPA-filter	42027
Korg för plastsäck	42369
Sugslang (Ø 38) 5 m	2105 + 2108
Antistatisk sugslang (Ø 38) 5 m (XL)	2012 + 2114



## Garanti

Garantitiden är två år och avser fabriktionsfel. Garantin gäller under förutsättning att maskinen används på normalt sätt och får den service som krävs. Normalt slitage ersätts inte. Reparationer ska utföras av Dustcontrol eller av person som godkänts av Dustcontrol. I annat fall förverkas garantin.

### Motor

Produktens motor(er) täcks inte av garantin. Exempel-livslängd för en motor kan vara mellan 600 - 700 driftstimmar. Kontakta Dustcontrol vid behov av motorbyte.

## Felsökning

Problem	Orsak	Åtgärd
Motorn går inte.	El ej ansluten.	Anslut el.
Motorn stannar direkt efter start.	Felaktig säkring.	Byt till korrekt säkring.
Motorn går men maskinen suger inte.	Sugslangen inte ansluten.	Anslut slang.
Motorn går men maskinen suger dåligt.	Hål på sugslangen.	Byt slang.
	Igensatt filter.	Rensa eller byt.
	Sugslangen för lång eller smal.	Byt slang.
	Slangen delvis igensatt.	Vänd slang eller rensa.
	Maskinens topp dåligt monterad.	Justera monteringen.
	Stoff har fastnat i cyklonen.	Ta bort toppen och rensa cyklonen.
Motorn stannar under drift.	Motorn är överhettad.	Kontrollera att maskinen inte är strypt & vänta tills maskinen har kylts ner (ca 30min).
Maskinen blåser ut damm.	Filtret har lossnat eller gått sönder.	Kontrollera och byt vid behov.
Onormalt ljud från maskinen.		Beställ service.

## EG-försäkran

Vi försäkrar härmed att DC 1800 H, Autostart & XL är i överensstämmelse med följande bestämmelser och standarder:

2006/42/EC, 2014/30/EU, 2014/35/EU, EN 60204-1:2018, EN1822-1:2019.

Dustcontrol AB



**Nina Uggowitzer / CEO & Technical Manager**

**2024-10-18**

## Reservdelar

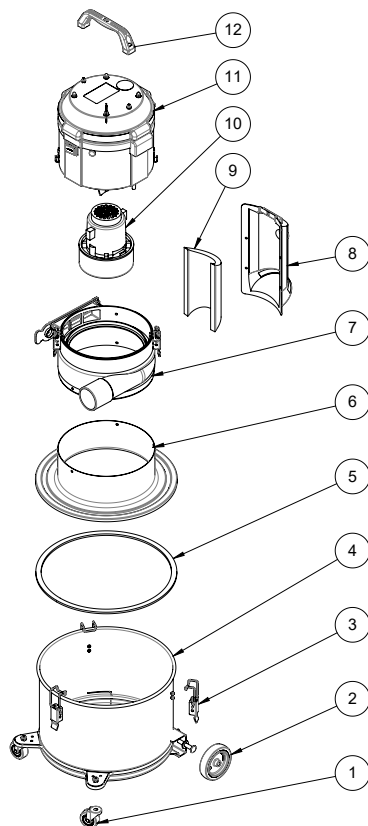

Nummer	Art no.	Benämning
1	42308	Länkhjul D50 H64
2	42307	Hjul D100
3	42365	Excenterlås
4*	42278-40	Behållare
	40444-1	Behållare XL
5	40514	Packning 15x8 Självhäftande
6	42276	Cyklon/Lock
7	940453-70	Inloppsmodul
8	42275	Utluftskanal
9	42284	Ljudabsorbent
10	41800	Motorpaket Eco 1285W
	41801	Motorpaket Auto Eco 1285W
11	41801-70	Motoröverdel, DC Auto Eco 1285W
12	426700	Handtag

# Kontakt

## Dustcontrol Worldwide

 **AT**  
Dustcontrol Ges.m.b.H.  
info@dustcontrol.at  
www.dustcontrol.at

 **AU**  
All Preparation Equipment  
www.allprep.com.au

 **BENELUX**  
Dust Solutions BV  
www.dustsolutions.nl

 **BG**  
Metaltech14 Ltd.  
metaltech14@abv.bg  
www.dustcontrolbg.com

 **CA** Dustcontrol  
Canada Inc.  
info@dustcontrol.ca  
www.dustcontrol.ca

 **CH**  
Rosset Technik Maschinen  
Werkzeuge AG  
www.rosset-technik.ch  
info@rosset-technik.ch

 **CL**  
Beckart Tecnologia Ambiental S.A.  
ambitec@ambitec.cl  
www.ambitec.cl

 **CN**  
Suzhou Dustcollect Filtration  
Technology Co. Ltd.  
wang@dustcollect.cn  
www.dustcollect.cn

 **CZ / SK** Ener  
Group CZ, S.R.O. Infolinka:  
+420 602 795 800  
info@energrou.cz  
www.prumysloveodsavani.cz/

 **DE**  
Dustcontrol GmbH  
info@dustcontrol.de  
www.dustcontrol.de

 **DK**  
Construction – Erenfred Pedersen A/S  
info@ep.dk  
www.ep.dk  
  
Industry – Dansk Procesventilation ApS  
info@dansk-procesventilation.dk  
www.dansk-procesventilation.dk

 **EE**  
G-Color Baltic OÜ  
sales@g-color.ee  
www.g-color.ee

 **ES**  
Barin, s.a.  
info@barin.es  
www.barin.es

 **GB**  
Dustcontrol UK Ltd.  
sales@dustcontrol.co.uk  
www.dustcontrol.co.uk

 **GR**  
Mavrogiannakis S.A  
ekttox@enternet.gr  
www.ekttoxefits.com.gr

 **FI**  
Dustcontrol FIN OY  
dc@dustcontrol.fi  
www.dustcontrol.fi

 **FR**  
Construction – SMH Equipements  
info@abequipements.com  
www.smhequipements.com

**Industry – Dustcontrol AB**  
info@dustcontrol.fra  
www.dustcontrol.fra

 **HR**  
Kermek d.o.o.  
kruno.nedeljko@kermek.com  
www.kermek.com

 **HU**  
Vandras Kft  
vandras@t-online.hu  
www.vandras.hu

 **IN**  
Advance Ventilation Pve Ltd.  
sales@advanceventilation.com  
www.advanceventilation.com

 **IT**  
Airum srl  
info@airum.com  
www.airum.com

 **KR**  
ESH Engineering Co.  
eshengco@gmail.com  
www.eshengco.com

 **LT**  
UAB Hidromega  
info@hidromega.lt  
www.hidromega.lt

 **LV**  
SIA Reaktivs  
reaktivs@reaktivs.lv  
www.reaktivs.lv

 **MY, ID**  
Stada EnviroSpace Bhd  
info@stada.com.my  
www.stada.com.my

 **NO**  
Teijo Norge A.S  
firmapost@teijo.no  
www.teijo.no

 **NZ**  
Artizan Diamond Tools  
enquiry@artizandiamond.co.nz  
www.artizandiamond.co.nz

 **PE**  
Efixo  
contacto@efixo.pe  
www.efixo.pe

 **PH**  
Sweden Concrete Machines Inc.  
peringe@packoskick.se  
www.swedenconcretemachines.ph

 **PL**  
Bart Sp. z o.o.  
info@bart-vent.pl  
www.bart-vent.pl

 **PT**  
Metec-Mecano Técnica, Lda.  
geral@metec.pt  
www.metec.pt

 **RO**  
AWS Elektrotehnik  
office@awstehnik.ro  
www.awstehnik.ro

General Contractor Industry SRL  
office@gci-grup.ro  
www.gci-grup.ro

 **RS**  
Enel Alati  
eneldoo@eunet.rs  
www.eneldoo.rs

 **RU**  
Centre Vacuum System  
panov.g@movers-td.com  
www.dustcontrolrus.ru

 **SE**  
Dustcontrol AB  
info@dustcontrol.se  
www.dustcontrol.com

 **SG**  
Stada EnviroSpace Pte Ltd  
Info@stada.com.my  
www.stada.com.my

 **TW**  
Goodland Enterprise Co., Ltd.  
sales@goodland.com.tw  
www.goodland.com.tw

 **TH**  
MCON Intertrade Co., Ltd.  
sales@mconintertrade.com  
www.mconintertrade.com

 **TR** Ventek  
Mühendislik Ltd.  
info@ventek.com.tr  
www.ventek.com.tr

 **AE**  
Global Enterprises Trading Co L.L.C.  
sales@globalentco.com  
www.globalentco.com

**GEM**  
Industrial Equipment Trading Co. Tel:  
+971 4 8840 474  
Email: gemuae@eim.ae

 **UA**  
MBK Obshemashkontrakt, JSC  
zao@omk.dp.ua  
www.omk.dp.ua

 **US**  
Dustcontrol Inc.  
info@dustcontrolusa.com  
www.dustcontrol.us

 **VN**  
Tayhostar JSC  
tayhostar@tayhostar.vn  
www.tayhostar.vn

Please contact the head office  
in Sweden if you do not find a  
distributor in your area.  
info@dustcontrol.se

## Legal notice



### **NOTICE**

Translation of the original user manual



### **IMPORTANT**

Read the user manual before using the machine.



### **IMPORTANT**

Dustcontrol reserves the right to change specifications without notice and is under no obligation to change previously delivered products. Dustcontrol is not responsible for errors or omissions in this user manual.



### **IMPORTANT**

All relevant state, regional and local safety regulations must be followed when installing and using this product. For safety reasons and to ensure compliance with documented system data, only the manufacturer shall carry out component repairs. Failure to follow this information may result in personal injury or equipment damage.



### **IMPORTANT**

All rights reserved. No part of this publication may be reproduced, distributed or transmitted in any form or by any means, including photocopying, recording or other electronic or mechanical means, without the prior written permission of the publisher. For permit inquiries, contact Dustcontrol.



### **NOTICE**

The product is manufactured by:

Dustcontrol AB  
Box 3088, Kumla Gårdsväg 14  
SE-145 03 Norsborg  
Tel: +46 8 531 940 00  
support@dustcontrol.se  
www.dustcontrol.com

## Safety regulations

### Intro

Read the following safety instructions before starting this machine. Save the user manual. If the safety regulations are not followed, the warranty does not apply. Personal and product damage can also occur. Dustcontrol is not responsible for damage to the equipment caused by incorrect installation or incorrect handling of the equipment.

### Warning

This machine is intended for professional use only.

Children should be supervised to ensure that they do not play with the machine.

Use only original accessories and consumables that are included in Dustcontrol's range.



#### WARNING

Use the machine for its intended purpose. Follow the instructions for the material to be extracted.



#### WARNING

This machine is only intended for extraction of dry material.



#### WARNING

When using electrical devices, basic safety instructions must be followed to reduce the risk of fire, electric shock or personal injury.



#### WARNING

Do not use the machine to extract hot, glowing particles or other ignitable material. Do not use the machine for explosive, unstable or self-igniting particles.



#### WARNING

If incorrect or non-OEM parts are used (especially filters, hoses and plastic bags), the machine can leak hazardous dust which may result in personal injury.

### Environmental protection

Recycle packaging and included components according to local regulations. For more information, contact your nearest recycling center or Dustcontrol for machine scrapping.

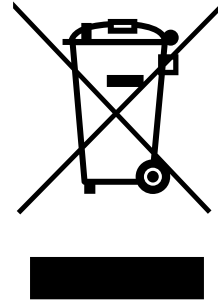
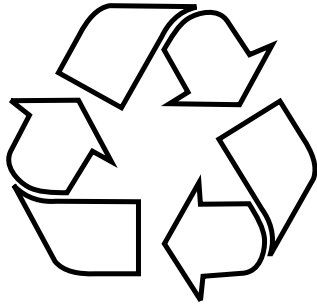

### WEEE (Waste of Electric and Electronic Equipment)

Valid for EU countries only: Electrical tools must not be disposed of with household waste. Under Directive 2002/96/EC relating to older electrical and electronic equipment and its implementation in national legislation, waste electrical tools must be disposed of separately and/or recycled in an environmentally responsible manner.

### Work environment

Do not expose the machine to moisture. Do not use it in damp or wet areas or close to flammable liquids or gases.



#### CAUTION

This machine must only be used and stored in a dry environment.



#### CAUTION

Do not rinse the machine with water.

### Overload



#### CAUTION

Never let the machine work fully throttled, as this poses a risk of overheating.

### Bodily injuries



#### WARNING

Never try to change electrical connections yourself. An error can be fatal!



#### WARNING

Never allow the extraction point to make contact with any part of the body. The strong negative pressure can damage blood vessels in the skin.





### **WARNING**

Protective gloves must be worn when assembling, handling and transporting the product.

## **Electric cable**



### **WARNING**

Never pull the machine by the power cord. Keep the power cord away from heat and sharp objects. Regularly inspect the power cord.

If using an extension cord, it must be waterproof.

The machine must not be used if the power cords or contacts are damaged.

If the power cord is damaged, it must be replaced by Dustcontrol or a Dustcontrol authorized service center.

## **Important action**

Turn off the main power switch and disconnect the machine from the power supply before cleaning or performing maintenance on the machine.

This machine may only be used if all filters are undamaged and correctly fitted.

## **Care**

Keep the machine clean and free from dust deposits. Ensure that the suction hose and all seals are intact and undamaged. Keep the carrying handles dry and free from oil and grease.

## **Control**

Regularly check the device for damage and wear. If damage occurs, these must be repaired by a Dustcontrol service technician or by a service workshop authorized by Dustcontrol.

## Functional Description

The dust collector works with negative pressure (suction) which drives the air through the suction hood / nozzle, hose system and pre- and dust separator. Coarse separation takes place in the unit's cyclone, which is a very efficient separation of increasingly coarser dust. The fine dust is separated in the unit's filter. Filter cleaning with air pulse gives the filters extra long life. The machine is equipped with HEPA filters.

The dust extractor is durable and reliable. It is particularly suitable for the suction and removal of dry, hazardous, non-combustible dust in class H as well as dust with ELV and dust of carcinogenic particles according to GefStoffV (German Hazardous substances Ordinance).

<b>H</b>	<p><b>WARNING:</b> This machine contains dust hazardous to health. Emptying and maintenance operations, including removal of the dust collection means, must only be carried out by authorised personnel wearing suitable personal protection. Do not operate without the full filtration system fitted.</p>	<p><b>ACHTUNG:</b> Dieses Gerät enthält gesundheitsschädlichen Staub. Leerungs- und Wartungsvorgänge, einschließlich der Beseitigung der Staubsammelbehälter, dürfen nur von Fachleuten durchgeführt werden, die entsprechende Schutzausrüstung tragen. Nicht ohne das vollständige Filtrationssystem betreiben.</p>	<p><b>VARNING:</b> Denna utrustning innehåller hälsofarligt damm. Tömning och service, inklusive filterbyte, får endast utföras av en fackman med lämplig personlig skyddsutrustning. Får ej användas utan komplett filtersystem.</p>	<b>H</b>
----------	--	--	---	----------

## Technical data

Technical data	DC 1800H	DC 1800H XL
HxWxD [mm]	780 x 405 x 390	1225 x 402 x 382
Weight [kg]	14	19
Inlet [mm]	Ø50	Ø50
Hose length Ø38 [m]	5	5
Collecting container [l]	20	55
Max. flow [m <sup>3</sup> /h]	205	205
Negative pressure, max. [kPa]	24	24
Power [W]	1285 (230 V)	1285 (230 V)
Auto: Power, connected tool*/min. 200 W	115/230 V/ 10A: 1340/1285 W 230 V/16 A: 2200 W	115/230 V/10 A: 1340/1285 W 230 V/16 A: 2200 W
Fine filter cellulose, area [m <sup>2</sup> ]	1,5	1,5
Filtration efficiency, fine filter, EN 60335-2-69, Class M [%]	99,9	99,9
Filter surface HEPA filter [m <sup>2</sup> ]	0,85	0,85
Degree of separation, machine, EN 60335-2-69, Appendix A-A, Class H [%]	99,995	99,995
Filter classification, EN 1822-1	HEPA H13	HEPA H13
Sound level [dB(A)]	< 66	< 68
IP	44	44

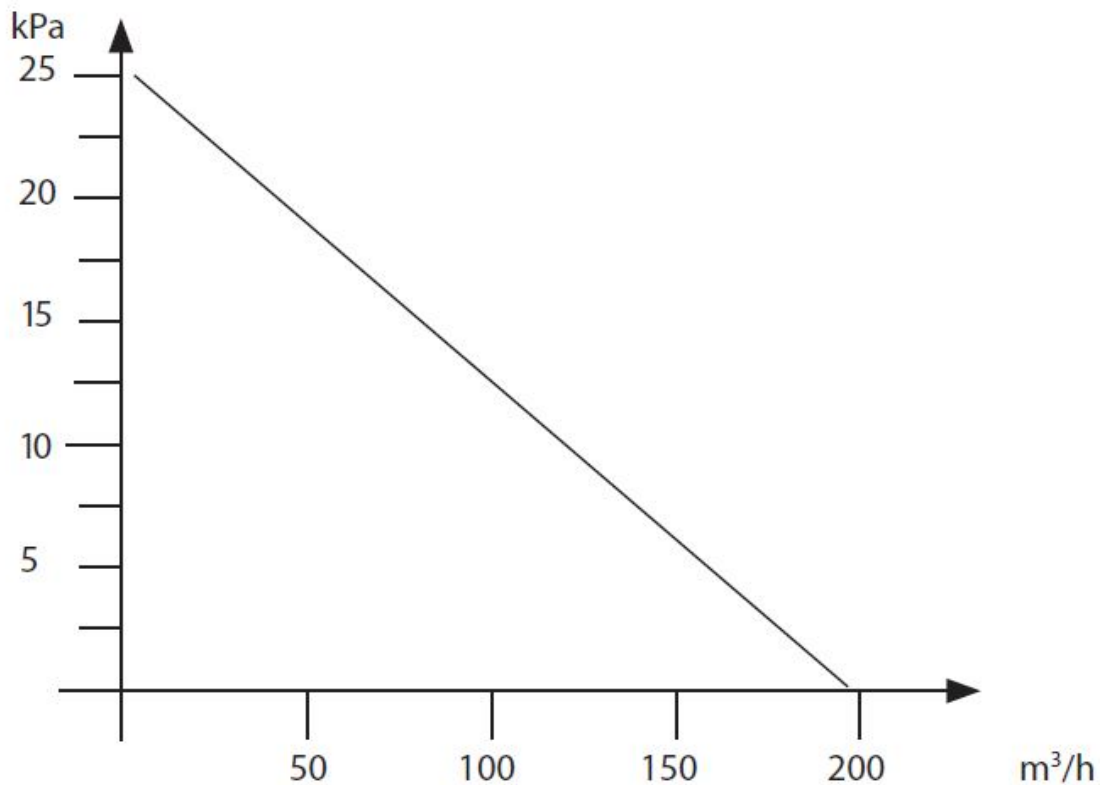

Pressure generation and air flow

## Operation

### Connection

Connect the machine to an electrical outlet with a voltage as per the machine's rating plate specifications.

### Autostart

Connect the power tool to the electrical outlet on the machine. Set the switch to AUTO. The machine will then automatically start when the tool is used. The machine turns off a few seconds after the connected tool is powered down. To manually start the extractor, set the switch to MAN.

### Filter cleaning:

The machine has a filter status indicator that lights up when the filter needs to be cleaned or replaced. The filters must be cleaned 1-2 times a day with continuous use and when the manometer needle is in the red field.

Cleaning the filter:

During filter cleaning, the machine should be running and the hose removed from the suction pipe.

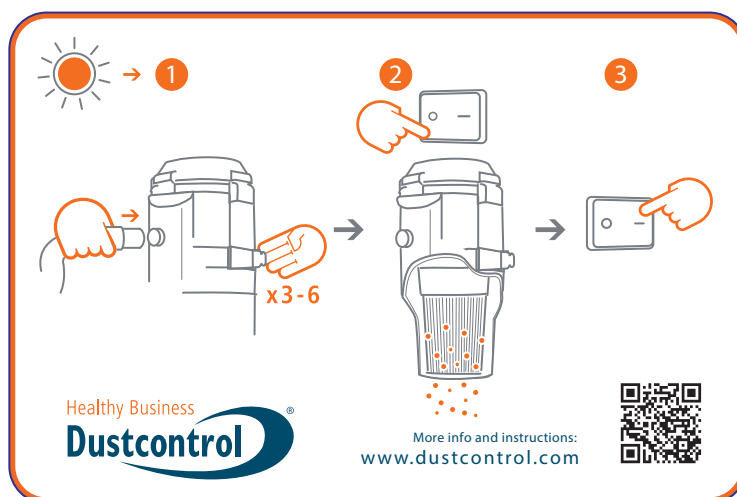

1. Press the connection sleeve against the black stopper on the exhaust duct or against the floor, so that maximum negative pressure is created in the cyclone. Then open the flap on the side 3-6 times. The air flows into the machine and cleans the filter with the pulse action.
2. Turn off the machine and let the material fall down. Reconnect the suction tube.
3. Start the machine.

### Emptying

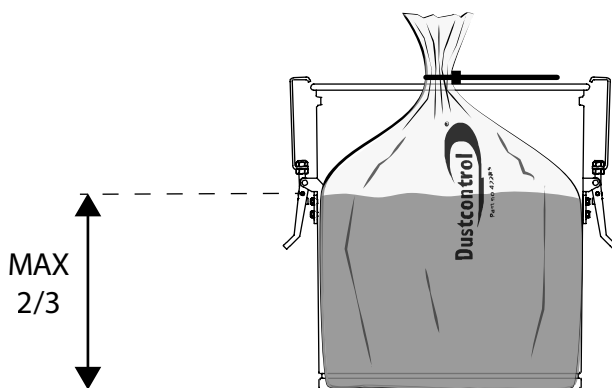

The container under the cyclone should be emptied when it is filled to a maximum of 2/3.

## Service & maintenance

### Cleaning

The machine must be switched off and unplugged before cleaning and maintenance.

### Filter replacement

The fine filter must be changed at least once a year. The HEPA filter must be replaced after 300 operating hours. Only original filters may be used.



#### WARNING

Filter replacement may only be performed by trained personnel. Use a protective mask and suitable equipment.

1. Loosen and lift off the cover to gain free access to the filter. Then put a plastic bag over the cyclone.
2. Lift the filter straight up into the plastic bag. Then check that the packing is complete. In case of damage, the gasket must be replaced to ensure tightness.
3. Tie the sack around the filter.
4. Dispose of the filter and plastic bag properly.

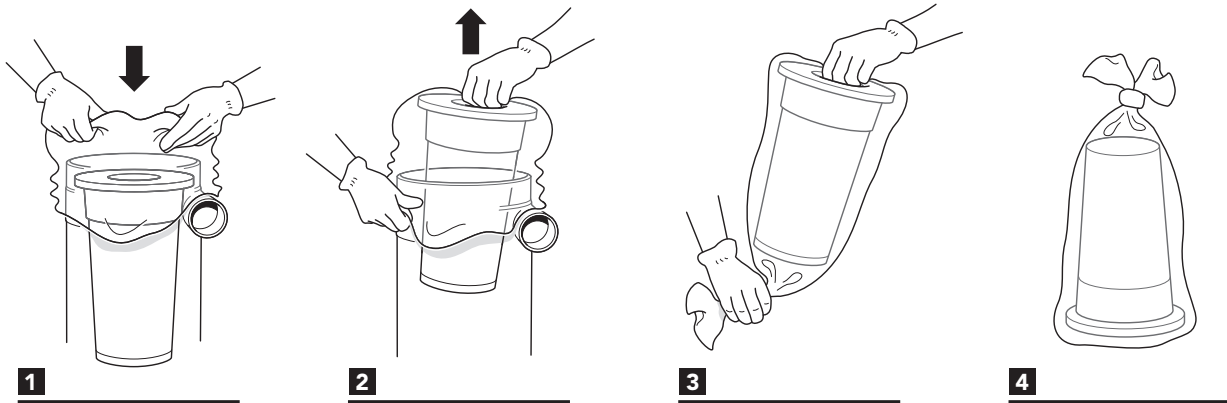

### Engine

The typical service life of a fan motor's original brushes is 600-700 hours. The brush can be replaced. The service life of the second brush set is approx. 400 hours, while that of the third set is approx. 300 hours. After this time, the motor is considered worn out and should be replaced.

### Regular check

Regularly check the power cord for damage.

## Consumables & accessories

Description	Part No.
Plastic bag, standard	42291
Plastic bag (XL)	42285
Fine filter, cellulose with integrated filter guard	42029
Fine filter PTFE, with integrated filter protection	42028-02
HEPA filter	42027
Basket for plastic bag	42369
Suction hose (Ø 38) 5 m	2105 + 2108
Antistatic suction hose (Ø 38) 5 m (XL)	2012 + 2114

## Warranty

The warranty period is two years and covers manufacturing defects. The warranty is valid on condition that the machine is used in the normal way and receives the required service. Normal wear and tear is not covered. Repairs must be carried out by Dustcontrol or personnel authorized by Dustcontrol. Otherwise, the warranty is void.

### Engine

The engine (s) of the product are not covered by the warranty. Sample life for an engine can be between 600 - 700 operating hours. Contact Dustcontrol if you need to change the engine.

## Troubleshooting

Problem	Cause	Action
Motor not running.	Power supply not connected.	Connect power supply.
Motor stops immediately after starting.	Incorrect fuse.	Replace with correct fuse.
Motor runs, but no suction.	Suction hose not connected.	Connect hose.
Motor runs, but poor suction.	Suction hose perforated.	Replace hose.
	Blocked filter.	Clean or replace.
	Suction hose too long or narrow.	Replace hose.
	Hose partially blocked.	Reverse or clean hose.
	Top of machine poorly fitted.	Adjust fitting.
The motor stops during operation.	Dust trapped in cyclone.	Remove top and clean cyclone.
	The motor is overheated.	Check that the machine is not throttled & wait until the machine has cooled down (approx. 30min).
Machine blows dust.	Filter loose or damaged.	Check and replace as necessary.
Abnormal sound from machine.		Book service.



## EC Declaration of Conformity

We hereby certify that the DC 1800 H, Autostart & XL is in compliance with the following regulations and standards:

2006/42/EC, 2014/30/EU, 2014/35/EU, EN 60204-1:2018, EN1822-1:2019.

Dustcontrol AB



**Nina Uggowitzner / CEO & Technical Manager**

**2024-10-18**

## Spare parts

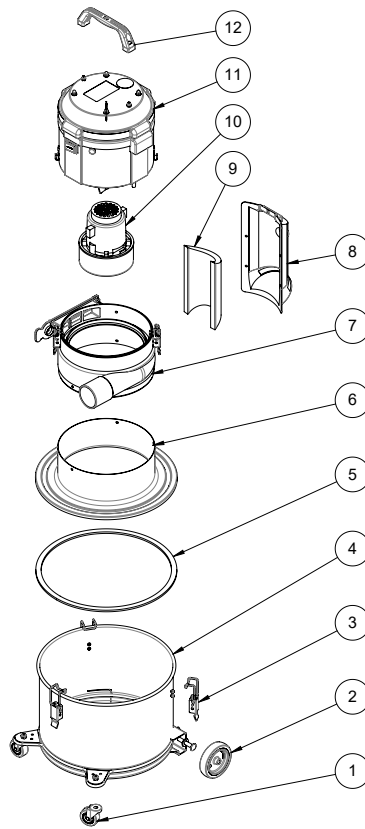

Number	Art. no.	Description
1	42308	Link wheel D50 H64
2	42307	Wheel D100
3	42365	Eccentric lock
4*	42278-40	Container
	40444-1	Container XL
5	40514	Gasket 15x8 Self-adhesive
6	42276	Cyclone/Cap
7	940453-70	Inlet module
8	42275	Exhaust duct
9	42284	Sound absorbent
10	41800	Engine package Eco 1285W
	41801	Engine package Auto Eco 1285W
11	41801-70	Motor top, DC Auto Eco 1285W
12	426700	Handle

# Contact

## Dustcontrol Worldwide



**AT**  
Dustcontrol Ges.m.b.H.  
info@dustcontrol.at  
www.dustcontrol.at



**AU**  
All Preparation Equipment  
www.allprep.com.au



**BENELUX**  
Dust Solutions BV  
www.dustsolutions.nl



**BG**  
Metaltech14 Ltd.  
metaltech14@abv.bg  
www.dustcontrolbg.com



**CA** Dustcontrol  
Canada Inc.  
info@dustcontrol.ca  
www.dustcontrol.ca



**CH**  
Rosset Technik Maschinen  
Werkzeuge AG  
info@rosset-technik.ch  
www.rosset-technik.ch



**CL**  
Beckart Tecnologia Ambiental S.A.  
ambitec@ambitec.cl  
www.ambitec.cl



**CN**  
Suzhou Dustcollect Filtration  
Technology Co. Ltd.  
wang@dustcollect.cn  
www.dustcollect.cn



**CZ / SK** Ener  
Group CZ, S.R.O. Infolinka:  
+420 602 795 800  
info@energrou.cz  
www.prumysloveodsavani.cz/



**DE**  
Dustcontrol GmbH  
info@dustcontrol.de  
www.dustcontrol.de



**DK**  
Construction – Erenfred Pedersen A/S  
info@ep.dk  
www.ep.dk

Industry – Dansk Procesventilation ApS  
info@dansk-procesventilation.dk  
www.dansk-procesventilation.dk



**EE**  
G-Color Baltic OÜ  
sales@g-color.ee  
www.g-color.ee



**ES**  
Barin, s.a.  
info@barin.es  
www.barin.es



**GB**  
Dustcontrol UK Ltd.  
sales@dustcontrol.co.uk  
www.dustcontrol.co.uk



**GR**  
Mavrogiannakis S.A  
ekttox@enternet.gr  
www.ekttoxefits.com.gr



**FI**  
Dustcontrol FIN OY  
dc@dustcontrol.fi  
www.dustcontrol.fi



**FR**  
Construction – SMH Equipements  
info@abequipements.com  
www.smhequipements.com



Industry – Dustcontrol AB  
info@dustcontrol.fra  
www.dustcontrol.fra



**HR**  
Kermek d.o.o.  
kruno.nedeljko@kermek.com  
www.kermek.com



**HU**  
Vandras Kft  
vandras@t-online.hu  
www.vandras.hu



**IN**  
Advance Ventilation Pve Ltd.  
sales@advanceventilation.com  
www.advanceventilation.com



**IT**  
Airum srl  
info@airum.com  
www.airum.com



**KR**  
ESH Engineering Co.  
eshengco@gmail.com  
www.eshengco.com



**LT**  
UAB Hidromega  
info@hidromega.lt  
www.hidromega.lt



**LV**  
SIA Reaktivs  
reaktivs@reaktivs.lv  
www.reaktivs.lv



**MY, ID**  
Stada EnviroSpace Bhd  
info@stada.com.my  
www.stada.com.my



**NO**  
Teijo Norge A.S  
firmapost@teijo.no  
www.teijo.no



**NZ**  
Artizan Diamond Tools  
enquiry@artizandiamond.co.nz  
www.artizandiamond.co.nz



**PE**  
Efixo  
contacto@efixo.pe  
www.efixo.pe



**PH**  
Sweden Concrete Machines Inc.  
peringe@packoskick.se  
www.swedenconcretemachines.ph



**PL**  
Bart Sp. z o.o.  
info@bart-vent.pl  
www.bart-vent.pl



**PT**  
Metec-Mecano Técnica, Lda.  
geral@metec.pt  
www.metec.pt



**RO**  
AWS Elektrotehnik  
office@awstehnik.ro  
www.awstehnik.ro

General Contractor Industry SRL  
office@gci-grup.ro  
www.gci-grup.ro



**RS**  
Enel Alati  
eneldoo@eunet.rs  
www.eneldoo.rs



**RU**  
Centre Vacuum System  
panov.g@movers-td.com  
www.dustcontrolrus.ru



**SE**  
Dustcontrol AB  
info@dustcontrol.se  
www.dustcontrol.com



**SG**  
Stada EnviroSpace Pte Ltd  
Info@stada.com.my  
www.stada.com.my



**TW**  
Goodland Enterprise Co., Ltd.  
sales@goodland.com.tw  
www.goodland.com.tw



**TH**  
MCON Intertrade Co., Ltd.  
sales@mconintertrade.com  
www.mconintertrade.com



**TR** Ventek  
Mühendislik Ltd.  
info@ventek.com.tr  
www.ventek.com.tr



**AE**  
Global Enterprises Trading Co L.L.C.  
sales@globalentco.com  
www.globalentco.com



**GEM**  
Industrial Equipment Trading Co. Tel:  
+971 4 8840 474  
Email: gemuae@eim.ae



**UA**  
MBK Obshemashkontrakt, JSC  
zao@omk.dp.ua  
www.omk.dp.ua



**US**  
Dustcontrol Inc.  
info@dustcontrolusa.com  
www.dustcontrol.us



**VN**  
Tayhostar JSC  
tayhostar@tayhostar.vn  
www.tayhostar.vn

Please contact the head office  
in Sweden if you do not find a  
distributor in your area.  
info@dustcontrol.se

## Rechtlicher Hinweis



### HINWEIS

Übersetzung der Original-Bedienungsanleitung



### WICHTIG

Lesen Sie die Bedienungsanleitung, bevor Sie die Maschine verwenden.



### WICHTIG

Dustcontrol behält sich das Recht vor, Spezifikationen ohne Vorankündigung zu ändern und ist nicht verpflichtet, bereits gelieferte Produkte zu ändern. Dustcontrol übernimmt keine Verantwortung für Fehler oder Auslassungen in dieser Bedienungsanleitung.



### WICHTIG

Bei der Installation und Verwendung dieses Produkts müssen alle relevanten staatlichen, regionalen und lokalen Sicherheitsvorschriften befolgt werden. Aus Sicherheitsgründen und zur Sicherstellung der Einhaltung dokumentierter Anlagendaten sollte die Reparatur von Komponenten ausschließlich vom Hersteller durchgeführt werden. Die Nichtbeachtung dieser Informationen kann zu Verletzungen oder Sachschäden führen.



### WICHTIG

Alle Rechte vorbehalten. Kein Teil dieser Veröffentlichung darf ohne vorherige schriftliche Genehmigung des Herausgebers in irgendeiner Form oder mit irgendwelchen Mitteln, einschließlich Fotokopie, Aufzeichnung oder anderen elektronischen oder mechanischen Mitteln, reproduziert, verbreitet oder übertragen werden. Für Genehmigungsanfragen wenden Sie sich bitte an Dustcontrol.



### HINWEIS

Das Produkt wird hergestellt von:

Dustcontrol AB  
Box 3088, Kumla Gårdsväg 14  
SE-145 03 Norsborg  
Tel: +46 8 531 940 00  
support@dustcontrol.se  
www.dustcontrol.com

## Sicherheitsvorschriften

### Einführung

Lesen Sie die folgenden Sicherheitshinweise, bevor Sie diese Maschine starten. Bewahren Sie die Bedienungsanleitung auf. Bei Nichtbeachtung der Sicherheitsvorschriften entfällt die Gewährleistung. Auch Personen- und Produktschäden können auftreten. Dustcontrol haftet nicht für Schäden an der Ausrüstung, die durch falsche Installation oder falsche Handhabung der Ausrüstung verursacht werden.

### Warnung

Diese Maschine ist nur für den professionellen Gebrauch bestimmt.

Kinder müssen beaufsichtigt werden, um sicherzustellen, dass sie nicht mit der Maschine spielen.

Verwenden Sie nur Originalzubehör und Verbrauchsmaterialien, die im Sortiment von Dustcontrol enthalten sind.



#### WARNUNG

Verwenden Sie die Maschine für den vorgesehenen Zweck. Befolgen Sie die Vorschriften für das abzusaugende Material.



#### WARNUNG

Diese Maschine ist ausschließlich für das Absaugen von trockenem Material vorgesehen.



#### WARNUNG

Bei der Verwendung elektrischer Geräte sind die grundsätzlichen Sicherheitsvorkehrungen zu befolgen, damit die Gefahr von Brand, Elektroschocks oder Verletzungen minimiert wird.



#### WARNUNG

Es dürfen keine heißen, glühenden Partikel oder sonstige Zündquellen in die Maschine gesaugt werden. Die Maschine darf nicht für explosive, instabile oder selbstzündende Partikel benutzt werden.



#### WARNUNG

Bei der Verwendung von fehlerhaften Artikeln oder Nicht-Originalteilen (vor allem Filter, Schläuche und Plastiksäcke) kann gesundheitsschädlicher Staub aus der Maschine austreten, und Sie gefährden Ihre Gesundheit.

### Umweltschutz

Recyceln Sie die Verpackung und die enthaltenen Komponenten gemäß den örtlichen Vorschriften. Für weitere Informationen wenden Sie sich an Ihr nächstgelegenes Recyclingzentrum oder an Dustcontrol für die Maschinenverschrottung.

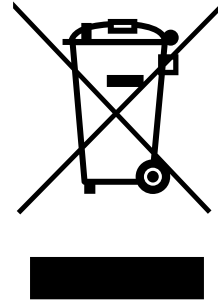
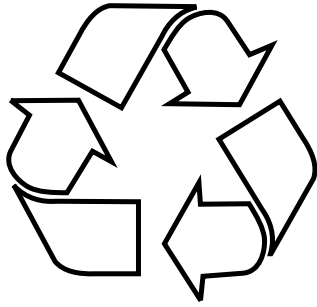

### WEEE (Abfall von Elektro- und Elektronik- Altgeräte)

Gilt nur für EU-Länder: Elektrowerkzeuge dürfen nicht im Hausmüll entsorgt werden. Gemäß Richtlinie 2002/96/EG für älteren Elektro- und Elektronikgeräten und ihrer Verwendung nach nationalem Recht muss ausgedientes Elektrowerkzeug separat aussortiert und einem umweltverträglichen Recycling zugeführt werden.

### Arbeitsumfeld

Die Maschine darf nicht in feuchten und nassen Bereichen oder in der Nähe von leicht entzündlichen Flüssigkeiten oder Gasen benutzt werden.



#### ACHTUNG

Diese Maschine darf nur in trockener Umgebung eingesetzt und aufbewahrt werden.



#### ACHTUNG

Die Maschine darf nicht mit Wasser abgespült werden.

### Überlast



#### ACHTUNG

Die Maschine darf niemals voll gedrosselt laufen, weil dann Überhitzungsgefahr besteht.

### Körperverletzungen



#### WARNUNG

Versuchen Sie niemals, elektrische Verbindungen eigenmächtig zu ändern. Ein Fehler kann Lebensgefahr bedeuten!



#### WARNUNG

Ansaugöffnungen dürfen niemals mit einem Körperteil in Berührung kommen. Der starke Unterdruck kann die Blutgefäße der Haut verletzen.



### **WARNUNG**

Bei der Montage, Handhabung und dem Transport des Produkts sind Schutzhandschuhe zu tragen.

## **Stromkabel**



### **WARNUNG**

Ziehen Sie die Maschine niemals am Stromkabel. Setzen Sie das Kabel weder Hitze noch scharfen Gegenständen aus. Überprüfen Sie das Kabel regelmäßig.

Beim verlängern des Netzkabels muss das verlängerungskabel wasserdicht sein.

Die Maschine darf nicht zum Einsatz kommen, wenn die Kabel oder Kontakte beschädigt sind.

Ist das Kabel beschädigt, muss es von Dustcontrol oder einer von Dustcontrol autorisierten Servicewerkstatt ausgetauscht werden.

## **Wichtige Aktion**

Schalten Sie den Hauptschalter ab und nehmen Sie die Maschine vom Netz, bevor Sie sie reinigen bzw. Wartungsarbeiten ausführen.

Diese Maschine darf nur verwendet werden, wenn alle Filter unbeschädigt und korrekt montiert sind.

## **Pflege**

Halten Sie die Maschine sauber und frei von Staubablagerungen. Achten Sie darauf, dass der Saugschlauch intakt ist, dass alle Dichtungen unbeschädigt und einwandfrei in Ordnung sind. Die Tragegriffe müssen stets trocken und frei von Öl und Fett sein.

## **Kontrolle**

Es ist regelmäßig sicherzustellen, dass die Maschine weder beschädigt ist noch Verschleiß aufweist. Eventuelle Schäden sind von einem Dustcontrol-Kundendiensttechniker oder einer offiziellen Dustcontrol-Kundendienstwerkstatt zu beheben.

## Funktionsbeschreibung

Der Staubabscheider arbeitet mit Unterdruck (Saug), der die Luft durch den Saugdeckel/Düse, das Schlauchsystem und den Vor- und Staubabscheider treibt. Im Zyklon der Anlage erfolgt eine Grobabscheidung, die eine sehr effektive Abscheidung zunehmend größerer Stäube ermöglicht. Der Feinstaub wird im Filter des Gerätes abgetrennt. Die Filterreinigung mit Luftimpuls verleiht den Filtern eine besonders lange Lebensdauer. Die Maschine ist mit einem HEPA-Filter ausgestattet.

Der Staubabscheider ist zuverlässig und robust. Das Gerät ist insbesondere zum Aufsaugen und Abscheiden von trockenen, gesundheitsschädlichen und nicht brennbaren Stäuben geeignet, welche in die Filterkategorie „H“ eingestuft sind.

<b>H</b>	<p><b>WARNING:</b> This machine contains dust hazardous to health. Emptying and maintenance operations, including removal of the dust collection means, must only be carried out by authorised personnel wearing suitable personal protection. Do not operate without the full filtration system fitted.</p>	<p><b>ACHTUNG:</b> Dieses Gerät enthält gesundheitsschädlichen Staub. Leerungs- und Wartungsvorgänge, einschließlich der Beseitigung der Staubsammelbehälter, dürfen nur von Fachleuten durchgeführt werden, die entsprechende Schutzausrüstung tragen. Nicht ohne das vollständige Filtrationssystem betreiben.</p>	<p><b>VARNING:</b> Denna utrustning innehåller hälsofarligt damm. Tömning och service, inklusive filterbyte, får endast utföras av en fackman med lämplig personlig skyddsutrustning. Får ej användas utan komplett filtersystem.</p>	<b>H</b>
----------	--	--	---	----------



## Technische Daten

Technische Daten	DC 1800H	DC 1800H XL
HxBxT [mm]	780 x 405 x 390	1225 x 402 x 382
Gewicht [kg]	14	19
Einlass [mm]	Ø50	Ø50
Schlauchlänge Ø38 [m]	5	5
Sammelbehälter [l]	20	55
Durchsatz max. [m <sup>3</sup> /h]	205	205
Unterdruck max. [kPa]	24	24
Leistungsaufnahme [W]	1285 (230 V)	1285 (230 V)
Auto: Leistung, angeschlossenes Werkzeug*/min 200W	115/230 V/ 10A: 1340/1285 W	115/230 V/10 A: 1340/1285 W
	230 V/16 A: 2200 W	230 V/16 A: 2200 W
Feinfilterzellulose, Fläche [m <sup>2</sup> ]	1,5	1,5
Feinfilter mit Trenngrad, EN 60335-2-69, Klasse M [%]	99,9	99,9
Filterfläche HEPA-Filter [m <sup>2</sup> ]	0,85	0,85
Abscheidegrad Maschine, EN 60335-2-69, Anlage A-A, Klasse H [%]	99,995	99,995
Filterklassifizierung, EN 1822-1	HEPA H13	HEPA H13
Schallpegel [dB(A)]	< 66	< 68
IP	44	44

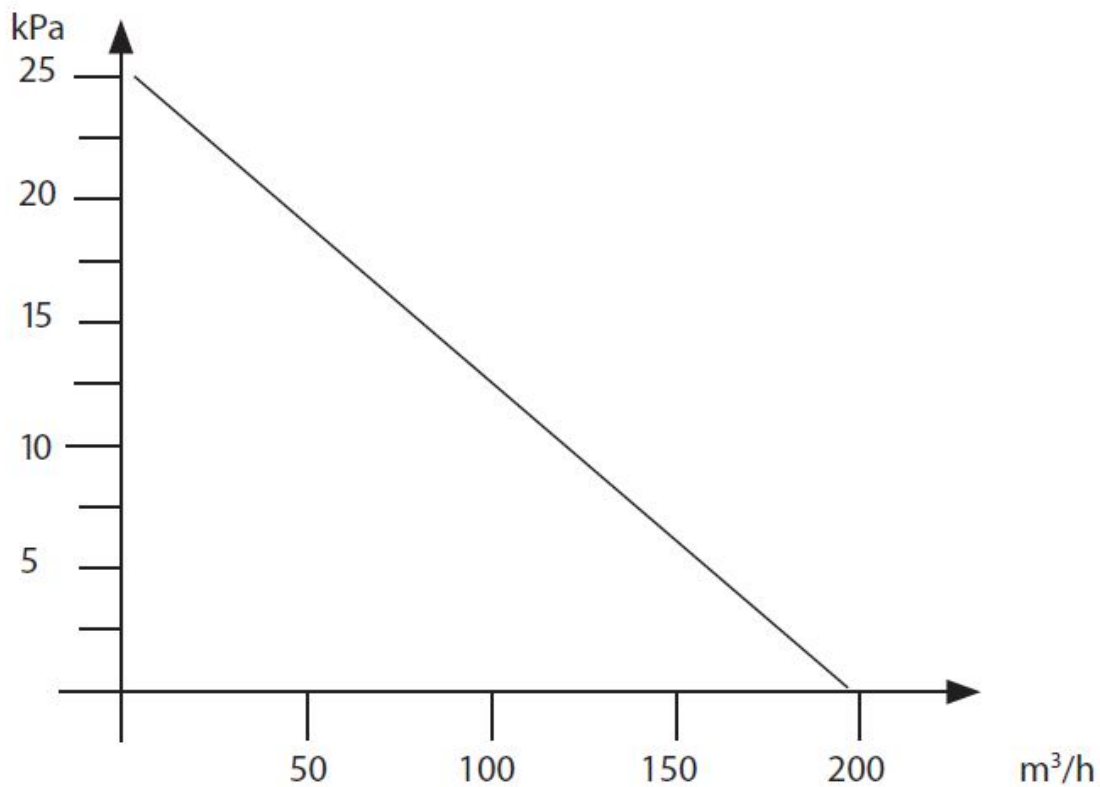

Druckerzeugung und Luftstrom

## Betrieb

### Anschließen

Die Maschine wird an eine Steckdose mit Spannung nach den Angaben auf dem Maschinentypenschild angeschlossen.

### Autostart

Das Elektrowerkzeug wird an den Anschluss an der Maschine angeschlossen. Stellen Sie den Schalter auf AUTO. Die Maschine startet dann automatisch, wenn das Werkzeug eingeschaltet wird. Die Maschine schaltet sich einige Sekunden, nachdem das angeschlossene Werkzeug abgeschaltet wurde, automatisch ab. Zum manuellen Start des Saugvorganges wird der Schalter auf MAN gestellt.

### Filterreinigung

Die Maschine ist mit einer Filteranzeigelampe ausgerüstet, die bei Reinigungs- oder Wechselbedarf des Filters leuchtet.

Reinigen des Filters:

Bei der Filterreinigung muss die Maschine in Betrieb und der Schlauch vom Ansaugrohr abgetrennt sein.

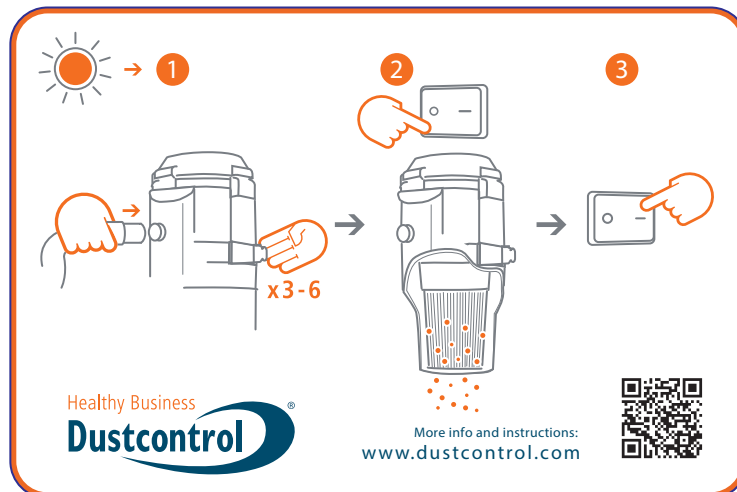

1. Drücken Sie die Anschlussmuffe gegen den schwarzen Stopfen am Abluftkanal oder gegen den Boden, sodass im Zyklon maximaler Unterdruck entsteht. Öffnen Sie dann die seitliche Klappe 3-6 Mal. Die Luft strömt in die Maschine und reinigt durch die Impulswirkung den Filter.
2. Schalten Sie die Maschine aus und lassen Sie das Material herunterfallen. Schließen Sie den Saugschlauch wieder an.
3. Starten Sie die Maschine.

### Leeren

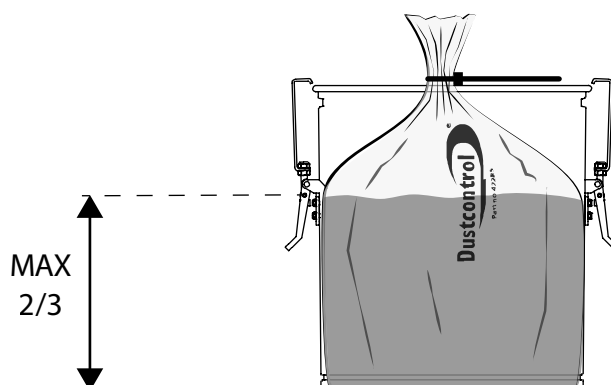

Der Behälter unter dem Zyklon sollte geleert werden, wenn er maximal zu 2/3 gefüllt ist.

## Service & Wartung

### Reinigung

Bei der Reinigung und Wartung der Maschine muss die Maschine ausgeschaltet und der Netzstecker gezogen sein.

### Filterwechsel

Der Feinfilter muss mindestens einmal im Jahr gewechselt werden. Der HEPA-Filter muss nach 300 Betriebsstunden ausgetauscht werden. Es dürfen nur Originalfilter verwendet werden.



#### WARNUNG

Der Filterwechsel darf nur von geschultem Personal vorgenommen werden. Schutzmaske und geeignete Ausrüstung tragen.

1. Lösen Sie die Abdeckung und heben Sie sie ab, um freien Zugang zum Filter zu erhalten. Dann stülpen Sie eine Plastiktüte über den Zyclon.
2. Heben Sie den Filter gerade nach oben in die Plastiktüte. Überprüfen Sie anschließend, ob die Verpackung vollständig ist. Im Schadensfall muss die Dichtung ausgetauscht werden, um die Dichtheit sicherzustellen.
3. Binden Sie den Sack um den Filter.
4. Entsorgen Sie den Filter und den Plastikbeutel ordnungsgemäß.

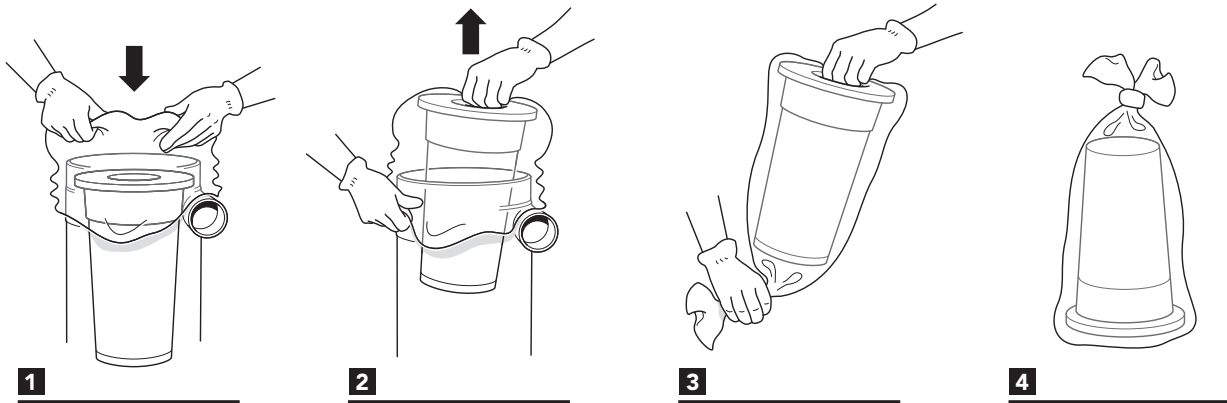

### Motor

Für kollektormotoren beträgt die typische Nutzlebensdauer der Originalbürsten 600-700 Stunden. Die Bürsten sind austauschbar. Für das zweite Bürstenpaket beträgt die Nutzlebensdauer ca. 400 Stunden, und für das dritte Bürstenpaket ca. 300 Stunden. Danach ist der Kollektor verschlissen, und der Motor muss ausgetauscht werden.

### Regelmäßige Kontrolle

Überprüfen Sie regelmäßig, ob das Stromkabel intakt ist.

## Verbrauchsmaterialien und Zubehör

Bezeichnung	Artikelnummer
Plastiksack, Standard	42291
Plastiksack (XL)	42285
Feinfilter aus Zellulose mit integriertem Filterschutz	42029
Feinfilter PTFE, mit integriertem Filterschutz	42028-02
HEPA-Filter	42027
Korb für Plastiksack	42369
Saugschlauch (Ø 38) 5 m	2105 + 2108
Antistatisch Saugschlauch (Ø 38) 5 m (XL)	2012 + 2114

## Gewährleistung

Die Gewährleistungsfrist beträgt zwei Jahre und bezieht sich auf Herstellungsmängel. Die Gewährleistung gilt, wenn die Maschine vorschriftsmäßig eingesetzt und gewartet wird. Normaler Verschleiß wird nicht ersetzt. Reparaturen sind von Dustcontrol oder einer von Dustcontrol autorisierten Person durchzuführen. Andernfalls verfällt die Gewährleistung.

### Motor

Der/die Motor(en) des Produkts fallen nicht unter die Garantie. Die Lebensdauer eines Motors kann zwischen 600 und 700 Betriebsstunden betragen. Wenden Sie sich an Dustcontrol, wenn Sie den Motor wechseln müssen.

## Fehlersuche und -behebung

Problem	Ursache	Maßnahme
Der Motor läuft nicht.	Nicht ans Stromnetz angeschlossen.	Ans Netz anschließen.
Der Motor stoppt unmittelbar nach dem Start.	Defekte Sicherung.	Gegen eine funktionstüchtige Sicherung austauschen.
Der Motor läuft, aber die Maschine saugt nicht.	Der Saugschlauch ist nicht angeschlossen.	Den Schlauch anschließen.
Der Motor läuft, aber die Maschine saugt schlecht.	Löcher im Saugschlauch.	Schlauch austauschen.
	Verstopfter Filter.	Reinigen oder austauschen.
	Saugschlauch zu lang oder zu dünn.	Schlauch austauschen.
	Schlauch teilweise verstopft.	Den Schlauch umgekehrt einsetzen und freisangen oder reinigen.
	Oberteil der Maschine ist mangelhaft montiert.	Einbau ändern.
	Staub hat sich im Zyklon festgesetzt.	Oberteil abnehmen und Zyklon reinigen.
Der Motor stoppt während des Betriebs.	Der Motor ist überhitzt.	Prüfen Sie, dass die Maschine nicht gedrosselt ist & warten Sie, bis die Maschine abgekühlt ist (ca. 30min).
Staub entweicht aus der Maschine.	Der Filter sitzt lose oder ist defekt.	Überprüfen und ggf. austauschen.
Unnormale Geräusche von der Maschine.		Kundendienst anfordern.

## EG-Konformitätserklärung

Hiermit bestätigen wir, dass der DC 1800 H, Autostart & XL den folgenden Vorschriften und Standards entspricht:

2006/42/EC, 2014/30/EU, 2014/35/EU, EN 60204-1:2018, EN1822-1:2019.

Dustcontrol AB



**Nina Uggowitzer / CEO & Technical Manager**

**2024-10-18**



## Ersatzteile

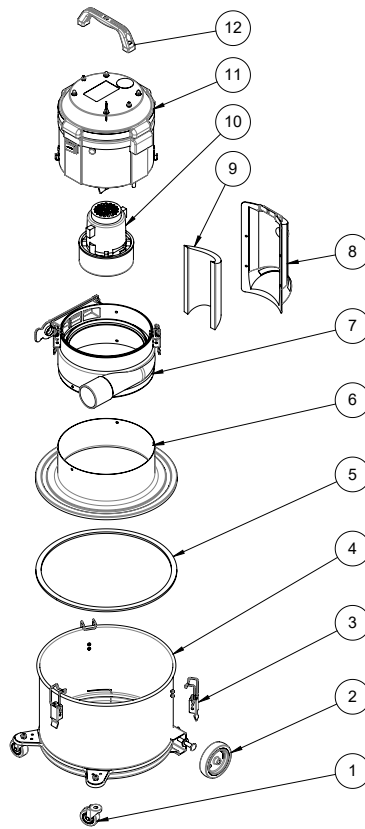

Nummer	Art Nr.	Bezeichnung
1	42308	Verbindungsrad D50 H64
2	42307	Rad D100
3	42365	Exzenterverschluss
4*	42278-40	Container
	40444-1	Behälter XL
5	40514	Dichtung 15x8 Selbstklebend
6	42276	Zyklon/Kappe
7	940453-70	Einlassmodul
8	42275	Abluftkanal
9	42284	Schallabsorbierend
10	41800	Motorpaket Eco 1285W
	41801	Motorpaket Auto Eco 1285W
11	41801-70	Motor oben, DC Auto Eco 1285W
12	426700	Handhaben

# Kontakt

## Dustcontrol Worldwide



**AT**  
Dustcontrol Ges.m.b.H.  
info@dustcontrol.at  
www.dustcontrol.at



**AU**  
All Preparation Equipment  
www.allprep.com.au



**BENELUX**  
Dust Solutions BV  
www.dustsolutions.nl



**BG**  
Metaltech14 Ltd.  
metaltech14@abv.bg  
www.dustcontrolbg.com



**CA** Dustcontrol  
Canada Inc.  
info@dustcontrol.ca  
www.dustcontrol.ca



**CH**  
Rosset Technik Maschinen  
Werkzeuge AG  
info@rosset-technik.ch  
www.rosset-technik.ch



**CL**  
Beckart Tecnologia Ambiental S.A.  
ambitec@ambitec.cl  
www.ambitec.cl



**CN**  
Suzhou Dustcollect Filtration  
Technology Co. Ltd.  
wang@dustcollect.cn  
www.dustcollect.cn



**CZ / SK** Ener  
Group CZ, S.R.O. Infolinka:  
+420 602 795 800  
info@energrou.cz  
www.prumysloveodsavani.cz/



**DE**  
Dustcontrol GmbH  
info@dustcontrol.de  
www.dustcontrol.de



**DK**  
Construction – Erenfred Pedersen A/S  
info@ep.dk  
www.ep.dk

Industry – Dansk Procesventilation ApS  
info@dansk-procesventilation.dk  
www.dansk-procesventilation.dk



**EE**  
G-Color Baltic OÜ  
sales@g-color.ee  
www.g-color.ee



**ES**  
Barin, s.a.  
info@barin.es  
www.barin.es



**GB**  
Dustcontrol UK Ltd.  
sales@dustcontrol.co.uk  
www.dustcontrol.co.uk



**GR**  
Mavrogiannakis S.A  
ekttox@enternet.gr  
www.ekttoxefis.com.gr



**FI**  
Dustcontrol FIN OY  
dc@dustcontrol.fi  
www.dustcontrol.fi



**FR**  
Construction – SMH Equipements  
info@abequipements.com  
www.smhequipements.com

Industry – Dustcontrol AB  
info@dustcontrol.fra  
www.dustcontrol.fra



**HR**  
Kermek d.o.o.  
kruno.nedeljko@kermek.com  
www.kermek.com



**HU**  
Vandras Kft  
vandras@t-online.hu  
www.vandras.hu



**IN**  
Advance Ventilation Pve Ltd.  
sales@advanceventilation.com  
www.advanceventilation.com



**IT**  
Airum srl  
info@airum.com  
www.airum.com



**KR**  
ESH Engineering Co.  
eshengco@gmail.com  
www.eshengco.com



**LT**  
UAB Hidromega  
info@hidromega.lt  
www.hidromega.lt



**LV**  
SIA Reaktivs  
reaktivs@reaktivs.lv  
www.reaktivs.lv



**MY, ID**  
Städa EnviroSPACE Bhd  
info@stada.com.my  
www.stada.com.my



**NO**  
Teijo Norge A.S  
firmapost@teijo.no  
www.teijo.no



**NZ**  
Artizan Diamond Tools  
enquiry@artizandiamond.co.nz  
www.artizandiamond.co.nz



**PE**  
Efixo  
contacto@efixo.pe  
www.efixo.pe



**PH**  
Sweden Concrete Machines Inc.  
peringe@packoskick.se  
www.swedenconcretemachines.ph



**PL**  
Bart Sp. z o.o.  
info@bart-vent.pl  
www.bart-vent.pl



**PT**  
Metec-Mecano Técnica, Lda.  
geral@metec.pt  
www.metec.pt



**RO**  
AWS Elektrotehnik  
office@awstehnik.ro  
www.awstehnik.ro

General Contractor Industry SRL  
office@gci-grup.ro  
www.gci-grup.ro



**RS**  
Enel Alati  
eneldoo@eunet.rs  
www.eneldoo.rs



**RU**  
Centre Vacuum System  
panov.g@movers-td.com  
www.dustcontrolrus.ru



**SE**  
Dustcontrol AB  
info@dustcontrol.se  
www.dustcontrol.com



**SG**  
Städa EnviroSPACE Pte Ltd  
Info@stada.com.my  
www.stada.com.my



**TW**  
Goodland Enterprise Co., Ltd.  
sales@goodland.com.tw  
www.goodland.com.tw



**TH**  
MCON Intertrade Co., Ltd.  
sales@mconintertrade.com  
www.mconintertrade.com



**TR** Ventek  
Mühendislik Ltd.  
info@ventek.com.tr  
www.ventek.com.tr



**AE**  
Global Enterprises Trading Co L.L.C.  
sales@globalentco.com  
www.globalentco.com

**GEM**  
Industrial Equipment Trading Co. Tel:  
+971 4 8840 474  
Email: gemuae@eim.ae



**UA**  
MBK Obshemashkontrakt, JSC  
zao@omk.dp.ua  
www.omk.dp.ua



**US**  
Dustcontrol Inc.  
info@dustcontrolusa.com  
www.dustcontrol.us



**VN**  
Tayhostar JSC  
tayhostar@tayhostar.vn  
www.tayhostar.vn

Please contact the head office  
in Sweden if you do not find a  
distributor in your area.  
info@dustcontrol.se

## Aviso legal



### AVISO

Traducción del manual de usuario original



### IMPORTANTE

Lea el manual de usuario antes de utilizar la máquina.



### IMPORTANTE

Dustcontrol se reserva el derecho de cambiar las especificaciones sin previo aviso y no tiene ninguna obligación de cambiar los productos entregados anteriormente. Dustcontrol no es responsable de los errores u omisiones en este manual del usuario.



### IMPORTANTE

Se deben seguir todas las normas de seguridad estatales, regionales y locales pertinentes al instalar y utilizar este producto. Por razones de seguridad y para garantizar el cumplimiento de los datos documentados del sistema, sólo el fabricante deberá realizar las reparaciones de los componentes. El incumplimiento de esta información puede provocar lesiones personales o daños al equipo.



### IMPORTANTE

Reservados todos los derechos. Ninguna parte de esta publicación puede reproducirse, distribuirse o transmitirse de ninguna forma ni por ningún medio, incluidas fotocopias, grabaciones u otros medios electrónicos o mecánicos, sin el permiso previo por escrito del editor. Para consultas sobre permisos, comuníquese con Dustcontrol.



### AVISO

El producto es fabricado por:

Dustcontrol AB  
Box 3088, Kumla Gårdsväg 14  
SE-145 03 Norsborg  
Tel: +46 8 531 940 00  
support@dustcontrol.se  
www.dustcontrol.com

## Normas de seguridad

### Introducción

Lea las siguientes instrucciones de seguridad antes de poner en marcha esta máquina. Guarde el manual de usuario. Si no se siguen las normas de seguridad, la garantía no se aplica. También pueden ocurrir daños personales y al producto. Dustcontrol no se hace responsable de los daños al equipo causados por una instalación incorrecta o un manejo incorrecto del equipo.

### Advertencia

Esta máquina está destinada únicamente a uso profesional.

Los niños deben ser supervisados para asegurarse de que no jueguen con la máquina.

Utilice solo accesorios y consumibles originales que se incluyen en la gama de Dustcontrol.



#### AVISO

Utilice la máquina para el objetivo para el que está prevista. Siga las instrucciones para el material que se aspira.



#### AVISO

Esta máquina está diseñada solo para aspirar material seco.



#### AVISO

Cuando se utilicen dispositivos eléctricos, se deben seguir las indicaciones de seguridad básicas de seguridad para reducir el riesgo de incendio, descarga eléctrica o lesiones personales.



#### AVISO

En la máquina no se debe aspirar ninguna partícula caliente o incandescente ni ninguna otra fuente de ignición. La máquina no se debe utilizar para partículas explosivas, inestables o de combustión espontánea.



#### AVISO

Si se utilizan artículos defectuosos o falsificados (sobre todo filtros, mangueras y bolsas de plástico), la máquina puede filtrar polvo nocivo y ello puede provocar lesiones personales.

### Protección ambiental

Recicle el embalaje y los componentes incluidos de acuerdo con las normativas locales. Para obtener más información, comuníquese con su centro de reciclaje más cercano o con Dustcontrol para el desguace de la máquina.

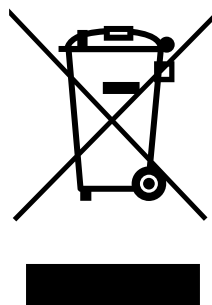
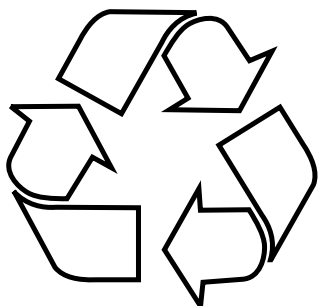

### RAEE (Residuos de aparatos eléctricos y electrónicos)

Solo se aplica a los países de la UE: Las herramientas eléctricas no deben desecharse junto con los residuos domésticos. En virtud de la Directiva 2002/96/CE relativa a los aparatos eléctricos y electrónicos más antiguos y su adecuación según la legislación nacional, las herramientas eléctricas al final de su vida útil se deben clasificar por separado y dejarse en lugares en los que se realice un reciclaje respetuoso con el medio ambiente.

### Ambiente de trabajo

No exponga la máquina a la humedad. No la utilice en espacios húmedos o mojados o cerca de líquidos o gases inflamables.



#### ATENCIÓN

Esta máquina solo se debe utilizar y guardar en un ambiente seco.



#### ATENCIÓN

No se debe enjuagar la máquina con agua.

### Sobrecarga



#### ATENCIÓN

No permita nunca que la máquina funcione ahogada, ya que esto representa un riesgo de sobrecalentamiento.

### Lesiones corporales



#### AVISO

No intente nunca cambiar las conexiones eléctricas usted mismo. ¡Un error puede ser letal!



### **AVISO**

No deje nunca que el punto de aspiración entre en contacto con ninguna parte del cuerpo. La fuerte presión negativa puede dañar los vasos sanguíneos de la piel.



### **AVISO**

Deben usarse guantes protectores durante el montaje, la manipulación y el transporte del producto.

## **cable electrico**



### **AVISO**

No arrastre nunca la máquina tirando del cable de alimentación. No exponga el cable de alimentación al calor ni a objetos afilados. Compruebe el cable de alimentación con regularidad.

Al empalmar el cable de alimentación, el alargador debe ser estanco.

La máquina no se debe utilizar si los cables de alimentación o los contactos están dañados.

Si el cable de alimentación está dañado, debe ser sustituido por Dustcontrol o un taller de servicio autorizado por Dustcontrol.

## **Acción importante**

Apague el interruptor de alimentación principal y desconecte la máquina de la fuente de alimentación antes de limpiar o realizar ninguna actividad de mantenimiento en la máquina.

Esta máquina sólo se puede utilizar si todos los filtros no están dañados y están correctamente instalados.

## **Cuidado**

Mantenga la máquina limpia y libre de depósitos de polvo. Asegúrese de que la manguera de aspiración esté entera y de que todas las juntas de estanqueidad estén intactas y sin defectos. Mantenga las asas de transporte secas y libres de aceite y grasa.

## **Control**

Compruebe periódicamente que la unidad no tiene daños ni desgaste. En caso de aparecer daños, los deben subsanar los técnicos de servicio de Dustcontrol o un taller de servicio autorizado por Dustcontrol.

## Descripción de las funciones

El colector de polvo funciona con presión negativa (succión) que impulsa el aire a través de la campana/boquilla de succión, el sistema de mangueras y el separador de polvo y previo. La separación gruesa se lleva a cabo en el ciclón de la unidad, que es una separación muy eficiente de polvo cada vez más grueso. El polvo fino se separa en el filtro de la unidad. La limpieza del filtro con pulsos de aire les da a los filtros una vida extra larga. La máquina está equipada con filtros HEPA.

El separador de polvo es fiable y práctico. Es especialmente adecuada para la aspiración y la extracción de polvo no inflamable seco y perjudicial de la clase H, así como de polvo con VLE y polvo de sustancias cancerígenas de conformidad con la GefStoffV (Ordenanza alemana sobre sustancias peligrosas).

<b>H</b>	<p><b>WARNING:</b> This machine contains dust hazardous to health. Emptying and maintenance operations, including removal of the dust collection means, must only be carried out by authorised personnel wearing suitable personal protection. Do not operate without the full filtration system fitted.</p>	<p><b>ACHTUNG:</b> Dieses Gerät enthält gesundheitsschädlichen Staub. Leerungs- und Wartungsvorgänge, einschließlich der Beseitigung der Staubsammelbehälter, dürfen nur von Fachleuten durchgeführt werden, die entsprechende Schutzausrüstung tragen. Nicht ohne das vollständige Filtrationssystem betreiben.</p>	<p><b>VARNING:</b> Denna utrustning innehåller hälsofarligt damm. Tömning och service, inklusive filterbyte, får endast utföras av en fackman med lämplig personlig skyddsutrustning. Får ej användas utan komplett filtersystem.</p>	<b>H</b>
----------	--	--	---	----------

## Datos técnicos

Datos técnicos	DC 1800H	DC 1800H XL
HxAxF [mm]	780 x 405 x 390	1225 x 402 x 382
Peso [kg]	14	19
Entrada [mm]	Ø50	Ø50
Longitud de manguera Ø38 [m]	5	5
Capacidad contenedor [l]	20	55
Caudal Max. [m <sup>3</sup> /h]	205	205
Presión negativa Max. [kPa]	24	24
Potencia de salida [W]	1285 (230 V)	1285 (230 V)
Auto: Herramienta eléctrica conectada*/mín. 200W	115/230 V/ 10A: 1340/1285 W	115/230 V/10 A: 1340/1285 W
	230 V/16 A: 2200 W	230 V/16 A: 2200 W
Celulosa de filtro fino, área [m <sup>2</sup> ]	1,5	1,5
Grado separación filtro fino, EN 60335-2-69, clase M [%]	99,9	99,9
Superficie filtrante filtro HEPA [m <sup>2</sup> ]	0,85	0,85
Máquina de grado de separación, EN 60335-2-69, Anexo A-A, Clase H [%]	99,995	99,995
Clasificación del filtro, EN 1822-1	HEPA H13	HEPA H13
Nivel de ruido [dB(A)]	< 66	< 68
IP	44	44

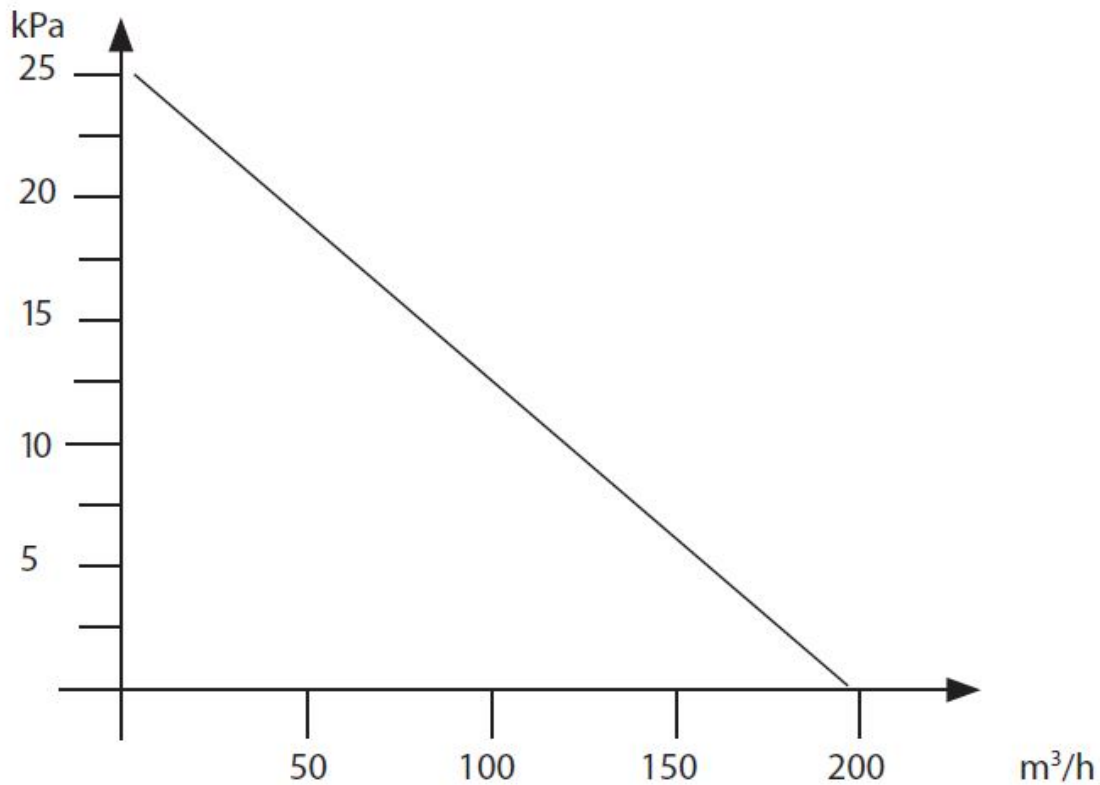

Generación de presión y flujo de aire.



## Operación

### Conexión

Conecte la máquina a una toma de corriente con tensión según las especificaciones de la placa de identificación de la máquina.

### Autoarranque

Conecte la herramienta eléctrica a la toma de corriente de la máquina. Coloque el selector en el modo automático (AUTO). La máquina se pone en marcha automáticamente cuando se arranca la herramienta. La máquina se apaga durante unos segundos cuando se apaga la herramienta conectada. Para arrancar manualmente la succión, ponga el selector en la posición MAN.

### Limpeza de los filtros

La máquina tiene un testigo indicador del filtro que se ilumina cuando hay que limpiar o cambiar el filtro.

Para limpiar el filtro, proceda como sigue:

Durante la limpieza del filtro, la máquina debe estar en marcha y la manguera se debe retirar del tubo de aspiración.

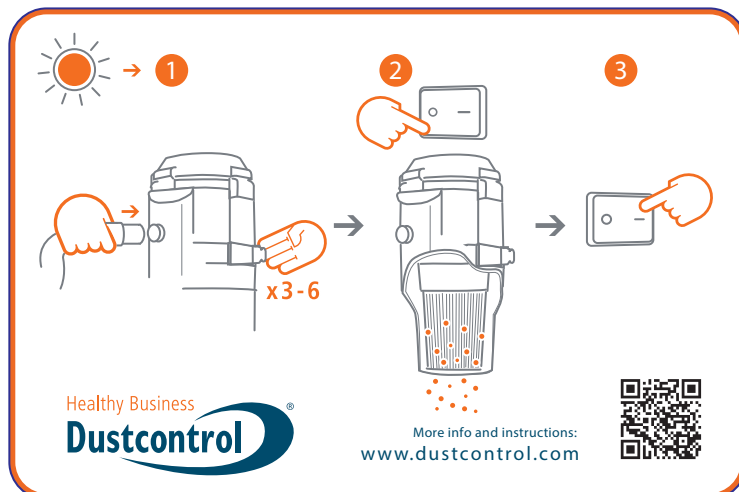

1. Presione el manguito de conexión contra el tope negro del conducto de escape o contra el suelo, de modo que se genere la máxima presión negativa en el ciclón. Luego abra la solapa lateral de 3 a 6 veces. El aire fluye hacia la máquina y limpia el filtro con la acción del pulso.
2. Apagar la máquina y dejar caer el material. Vuelva a conectar el tubo de succión.
3. Inicie la máquina.

### Vaciando

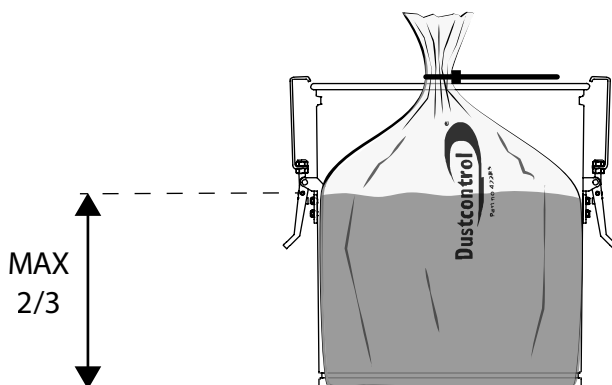

El recipiente debajo del ciclón se debe vaciar cuando esté lleno hasta un máximo de 2/3.

## Servicio y mantenimiento

### Limpeza

Durante la limpieza y el mantenimiento de la máquina, ésta debe estar apagada y desenchufada.

### Reemplazo de filtro

El filtro fino debe cambiarse al menos una vez al año. El filtro HEPA debe reemplazarse después de 300 horas de funcionamiento. Sólo se pueden utilizar filtros originales.



#### AVISO

El cambio de los filtros solo lo debe realizar personal formado. Utilice una mascarilla protectora y el equipo adecuado.

1. Afloje y levante la tapa para tener libre acceso al filtro. Luego coloque una bolsa de plástico sobre el ciclón.
2. Levante el filtro hacia arriba dentro de la bolsa de plástico. Luego verifique que el embalaje esté completo. En caso de daño, se debe reemplazar la junta para garantizar la estanqueidad.
3. Ate la bolsa alrededor del filtro.
4. Deseche correctamente el filtro y la bolsa de plástico.

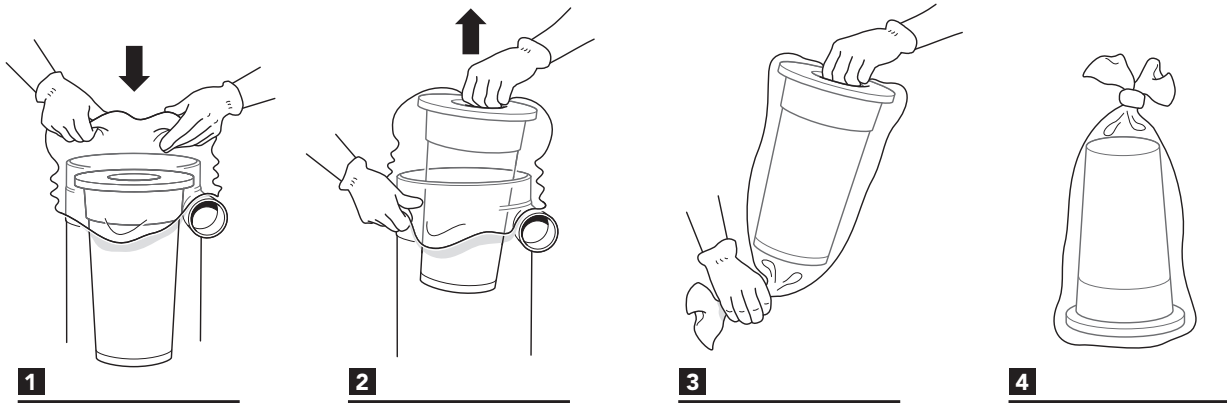

### Motor

Para los motores del ventilador, la vida útil típica de los cepillos originales es de 600-700 horas. El cepillo se puede cambiar. Para el segundo paquete del cepillo, la vida útil es de aprox. 400 horas y para el tercer paquete del cepillo es de unas 300 horas. Después de este tiempo, el colector se desgasta hay que cambiar el motor.

### Control periódico

Verifique periódicamente que el cable de alimentación no esté dañado.

## Consumibles y accesorios

Denominación	N.º de artículo
Bolsa de plástico, estándar	42291
Bolsa de plástico (XL)	42285
Filtro fino de celulosa, con protección del filtro integrada	42029
Filtro fino de PTFE, con protección de filtro integrada	42028-02
filtro HEPA	42027
Cesta para la bolsa de plástico	42369
Manguera de aspiración (Ø 38) 5 m	2105 + 2108
Manguera de aspiración antiestática (Ø 38) 5 m (XL)	2012 + 2114

## Garantía

El período de garantía es de dos años y cubre los defectos de fabricación. La garantía se aplica siempre que la máquina se utilice de manera normal y reciba la puesta a punto requerida. No se sustituyen las piezas que han sufrido un desgaste normal. Las reparaciones las deberán realizar Dustcontrol o una persona autorizada por Dustcontrol. De lo contrario, la garantía quedará anulada.

### **Motor**

El(los) motor(es) del producto no están cubiertos por la garantía. La vida útil de un motor puede ser de 600 a 700 horas de funcionamiento. Póngase en contacto con Dustcontrol si necesita cambiar el motor.

## DetECCIÓN Y RESOLUCIÓN DE PROBLEMAS

Problema	Causa	Solución
El motor no funciona.	La electricidad no está conectada.	Conecte la electricidad.
El motor se detiene inmediatamente después de arrancar.	Fusible defectuoso.	Cambie y ponga un fusible correcto.
El motor funciona pero la máquina no succiona.	La manguera de succión no está conectada.	Conecte la manguera.
El motor funciona pero la máquina succiona mal.	La manguera de succión tiene agujeros.	Cambie la manguera.
	Filtro obstruido.	Límpielo o cámbielo.
	La manguera de succión es demasiado larga o demasiado estrecha.	Cambie la manguera.
	La manguera está parcialmente obstruida.	Gire la manguera o límpiela.
	La parte superior de la máquina está mal montada.	Ajuste el ensamblaje.
	Se ha acumulado polvo en el ciclón.	Quite la parte superior y limpie el ciclón.
El motor se detiene durante el funcionamiento.	El motor está sobrecalentado.	Verifique que la máquina no esté acelerada y espere hasta que la máquina se haya enfriado (aprox. 30 min).
La máquina expulsa polvo.	El filtro se ha aflojado o se ha roto.	Verifíquelo y sustitúyalo de ser preciso.
Ruido anormal procedente de la máquina.		Concierte una cita para que la pongan a punto.

## Declaración de conformidad para el mercado CE

Por la presente certificamos que el DC 1800 H, Autostart y XL cumple con las siguientes regulaciones y estándares:

2006/42/EC, 2014/30/EU, 2014/35/EU, EN 60204-1:2018, EN1822-1:2019.

Dustcontrol AB



**Nina Uggowitzer / CEO & Technical Manager**

**2024-10-18**

## Piezas de repuesto

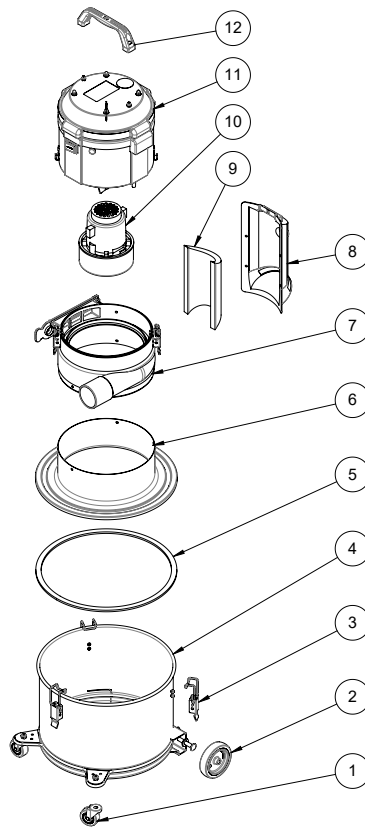

Número	N.º de artículo	Denominación
1	42308	Rueda de enlace D50 H64
2	42307	Rueda D100
3	42365	cerradura excéntrica
4*	42278-40	Recipiente
	40444-1	Contenedor XL
5	40514	Junta 15x8 Autoadhesiva
6	42276	Ciclón/Gorra
7	940453-70	Módulo de entrada
8	42275	Conducto de escape
9	42284	absorbente de sonido
10	41800	Paquete de motor Eco 1285W
	41801	Paquete de motor Auto Eco 1285W
11	41801-70	Motor superior, CC Auto Eco 1285W
12	426700	Manejar



# Contacto

## Dustcontrol Worldwide



**AT**  
Dustcontrol Ges.m.b.H.  
info@dustcontrol.at  
www.dustcontrol.at



**AU**  
All Preparation Equipment  
www.allprep.com.au



**BENELUX**  
Dust Solutions BV  
www.dustsolutions.nl



**BG**  
Metaltech14 Ltd.  
metaltech14@abv.bg  
www.dustcontrolbg.com



**CA** Dustcontrol  
Canada Inc.  
info@dustcontrol.ca  
www.dustcontrol.ca



**CH**  
Rosset Technik Maschinen  
Werkzeuge AG  
info@rosset-technik.ch  
www.rosset-technik.ch



**CL**  
Beckart Tecnologia Ambiental S.A.  
ambitec@ambitec.cl  
www.ambitec.cl



**CN**  
Suzhou Dustcollect Filtration  
Technology Co. Ltd.  
wang@dustcollect.cn  
www.dustcollect.cn



**CZ / SK** Ener  
Group CZ, S.R.O. Infolinka:  
+420 602 795 800  
info@energrou.cz  
www.prumysloveodsavani.cz/



**DE**  
Dustcontrol GmbH  
info@dustcontrol.de  
www.dustcontrol.de



**DK**  
Construction – Erenfred Pedersen A/S  
info@ep.dk  
www.ep.dk  
  
Industry – Dansk Procesventilation ApS  
info@dansk-procesventilation.dk  
www.dansk-procesventilation.dk



**EE**  
G-Color Baltic OÜ  
sales@g-color.ee  
www.g-color.ee



**ES**  
Barin, s.a.  
info@barin.es  
www.barin.es



**GB**  
Dustcontrol UK Ltd.  
sales@dustcontrol.co.uk  
www.dustcontrol.co.uk



**GR**  
Mavrogiannakis S.A  
ekttox@enternet.gr  
www.ekttoxefits.com.gr



**FI**  
Dustcontrol FIN OY  
dc@dustcontrol.fi  
www.dustcontrol.fi



**FR**  
Construction – SMH Equipements  
info@abequipements.com  
www.smhequipements.com



Industry – Dustcontrol AB  
info@dustcontrol.fra  
www.dustcontrol.fra



**HR**  
Kermek d.o.o.  
kruno.nedeljko@kermek.com  
www.kermek.com



**HU**  
Vandras Kft  
vandras@t-online.hu  
www.vandras.hu



**IN**  
Advance Ventilation Pve Ltd.  
sales@advanceventilation.com  
www.advanceventilation.com



**IT**  
Airum srl  
info@airum.com  
www.airum.com



**KR**  
ESH Engineering Co.  
eshengco@gmail.com  
www.eshengco.com



**LT**  
UAB Hidromega  
info@hidromega.lt  
www.hidromega.lt



**LV**  
SIA Reaktivs  
reaktivs@reaktivs.lv  
www.reaktivs.lv



**MY, ID**  
Städa Enviroospace Bhd  
info@stada.com.my  
www.stada.com.my



**NO**  
Teijo Norge A.S  
firmapost@teijo.no  
www.teijo.no



**NZ**  
Artizan Diamond Tools  
enquiry@artizandiamond.co.nz  
www.artizandiamond.co.nz



**PE**  
Efixo  
contacto@efixo.pe  
www.efixo.pe



**PH**  
Sweden Concrete Machines Inc.  
peringe@packoskick.se  
www.swedenconcretemachines.ph



**PL**  
Bart Sp. z o.o.  
info@bart-vent.pl  
www.bart-vent.pl



**PT**  
Metec-Mecano Técnica, Lda.  
geral@metec.pt  
www.metec.pt



**RO**  
AWS Elektrotehnik  
office@awstehnik.ro  
www.awstehnik.ro

General Contractor Industry SRL  
office@gci-grup.ro  
www.gci-grup.ro



**RS**  
Enel Alati  
eneldoo@eunet.rs  
www.eneldoo.rs



**RU**  
Centre Vacuum System  
panov.g@movers-td.com  
www.dustcontrolrus.ru



**SE**  
Dustcontrol AB  
info@dustcontrol.se  
www.dustcontrol.com



**SG**  
Städa Enviroospace Pte Ltd  
Info@stada.com.my  
www.stada.com.my



**TW**  
Goodland Enterprise Co., Ltd.  
sales@goodland.com.tw  
www.goodland.com.tw



**TH**  
MCON Intertrade Co., Ltd.  
sales@mconintertrade.com  
www.mconintertrade.com



**TR** Ventek  
Mühendislik Ltd.  
info@ventek.com.tr  
www.ventek.com.tr



**AE**  
Global Enterprises Trading Co L.L.C.  
sales@globalentco.com  
www.globalentco.com



**GEM**  
Industrial Equipment Trading Co. Tel:  
+971 4 8840 474  
Email: gemuae@eim.ae



**UA**  
MBK Obshemashkontrakt, JSC  
zao@omk.dp.ua  
www.omk.dp.ua



**US**  
Dustcontrol Inc.  
info@dustcontrolusa.com  
www.dustcontrol.us



**VN**  
Tayhostar JSC  
tayhostar@tayhostar.vn  
www.tayhostar.vn

Please contact the head office  
in Sweden if you do not find a  
distributor in your area.  
info@dustcontrol.se

## Mentions légales



### AVIS

Traduction du manuel d'utilisation original



### IMPORTANT

Lisez le manuel d'utilisation avant d'utiliser la machine.



### IMPORTANT

Dustcontrol se réserve le droit de modifier les spécifications sans préavis et n'a aucune obligation de modifier les produits précédemment livrés. Dustcontrol n'est pas responsable des erreurs ou omissions dans ce manuel d'utilisation.



### IMPORTANT

Toutes les réglementations de sécurité nationales, régionales et locales pertinentes doivent être respectées lors de l'installation et de l'utilisation de ce produit. Pour des raisons de sécurité et pour garantir le respect des données système documentées, seul le fabricant doit effectuer les réparations des composants. Le non-respect de ces informations peut entraîner des blessures corporelles ou des dommages matériels.



### IMPORTANT

Tous droits réservés. Aucune partie de cette publication ne peut être reproduite, distribuée ou transmise sous quelque forme ou par quelque moyen que ce soit, y compris la photocopie, l'enregistrement ou tout autre moyen électronique ou mécanique, sans l'autorisation écrite préalable de l'éditeur. Pour les demandes de permis, contactez Dustcontrol.



### AVIS

Le produit est fabriqué par :

Dustcontrol AB  
Box 3088, Kumla Gårdsväg 14  
SE-145 03 Norsborg  
Tel: +46 8 531 940 00  
support@dustcontrol.se  
www.dustcontrol.com

## Règles de sécurité

### Introduction

Lisez les instructions de sécurité suivantes avant de démarrer cette machine. Enregistrez le manuel d'utilisation. Si les règles de sécurité ne sont pas respectées, la garantie ne s'applique pas. Des dommages personnels et matériels peuvent également survenir. Dustcontrol n'est pas responsable des dommages causés à l'équipement par une installation incorrecte ou une mauvaise manipulation de l'équipement.

### Avertissement

Cette machine est destinée à un usage professionnel uniquement.

Les enfants doivent être surveillés pour s'assurer qu'ils ne jouent pas avec la machine.

N'utilisez que des accessoires et consommables d'origine inclus dans la gamme Dustcontrol.



#### AVERTISSEMENT

Utiliser la machine pour l'usage prévu. Suivre les instructions relatives au matériau aspiré.



#### AVERTISSEMENT

Cette machine est uniquement conçue pour l'aspiration de matière sèche.



#### AVERTISSEMENT

Lors de l'utilisation de dispositifs électriques, les consignes de sécurité de base doivent être suivies pour réduire le risque d'incendie, de choc électrique ou de blessure.



#### AVERTISSEMENT

Aucune particule chaude, incandescente ou autre source d'inflammation ne doit être aspirée par la machine. La machine ne doit pas être utilisée pour des particules explosives, instables ou auto-inflammables.



#### AVERTISSEMENT

Lors de l'utilisation d'articles défectueux ou non d'origine (en particulier les filtres, les tuyaux et les sacs en plastique), des fuites de poussières nocives avec risque de blessures sont possibles.

### Protection de l'environnement

Recyclez l'emballage et les composants inclus conformément aux réglementations locales. Pour plus d'informations, contactez votre déchetterie la plus proche ou Dustcontrol pour la mise au rebut des machines.

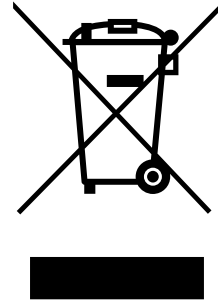
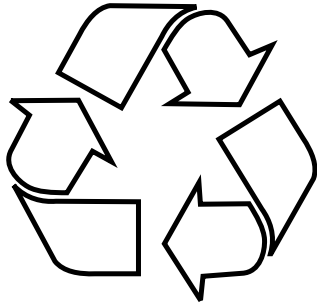

### **DEEE (Déchets d'équipements électriques et électroniques)**

S'applique uniquement aux pays de l'UE : Les outils électriques ne doivent pas être jetés dans les ordures ménagères. En vertu de la directive 2002/96/CE relative aux équipements électriques et électroniques plus anciens et de son application en droit national, les outils électriques en fin de vie doivent être triés et soumis à un recyclage respectueux de l'environnement.

### **Environnement de travail**

Ne pas exposer la machine à l'humidité. Ne pas utiliser la machine dans des espaces humides et mouillés ou à proximité de liquides ou de gaz inflammables.



#### **ATTENTION**

Utiliser et entreposer la machine uniquement dans un environnement sec.



#### **ATTENTION**

Ne pas rincer la machine avec de l'eau.

### **Surcharge**



#### **ATTENTION**

Ne jamais laisser la machine tourner à une puissance de moteur réduite en raison du risque de surchauffe.

### **Blessures corporelles**



#### **AVERTISSEMENT**

Ne jamais prendre l'initiative de modifier les branchements électriques. Une erreur pourrait être fatale !



### **AVERTISSEMENT**

Ne jamais laisser le point d'aspiration entrer en contact avec une partie quelconque du corps. La forte dépression peut endommager les vaisseaux sanguins de la peau.



### **AVERTISSEMENT**

Des gants de protection doivent être portés lors du montage, de la manipulation et du transport du produit.

## **Câble électrique**



### **AVERTISSEMENT**

Ne jamais tirer la machine par le cordon d'alimentation. Ne pas exposer le cordon d'alimentation à la chaleur ou aux objets tranchants. Vérifier régulièrement le cordon d'alimentation.

Lors de l'épissage du cordon d'alimentation, l'extension doit être étanche.

La machine ne doit pas être utilisée si les cordons d'alimentation ou les contacts sont endommagés.

Si le cordon d'alimentation est endommagé, il doit être remplacé par Dustcontrol ou par un centre de service autorisé Dustcontrol.

## **Action importante**

Éteindre la machine avec l'interrupteur principal et la débrancher de l'alimentation secteur avant tout nettoyage ou entretien.

Cette machine ne peut être utilisée que si tous les filtres sont en bon état et correctement installés.

## **Soins**

La machine doit toujours être propre et sans dépôts de poussière. Vérifier que le tuyau d'aspiration est en bon état et que tous les joints sont intacts et impeccables. Les poignées de transport doivent toujours être sèches et exemptes d'huile et de graisse.

## **Contrôle**

Contrôler régulièrement que l'unité n'est pas endommagée ni usée. En cas de dommages, ceux-ci doivent être réparés par le technicien de maintenance de Dustcontrol ou par un atelier de maintenance agréé par Dustcontrol.

## Description fonctionnelle

Le dépoussiéreur fonctionne avec une pression négative (aspiration) qui entraîne l'air à travers la hotte d'aspiration / la buse, le système de tuyaux et le pré- et séparateur de poussière. La séparation grossière a lieu dans le cyclone de l'unité, qui est une séparation très efficace des poussières de plus en plus grossières. La poussière fine est séparée dans le filtre de l'appareil. Le nettoyage du filtre avec impulsion d'air donne aux filtres une durée de vie extra longue. La machine est équipée de filtres HEPA.

Le dépoussiéreur est fiable et résistant. Il convient particulièrement à l'aspiration et à l'élimination des poussières sèches, nocives, non inflammables dans la classe H ainsi que des poussières avec ELV et des poussières de substances cancérogènes selon GefStoffV (ordonnance allemande sur les substances dangereuses).

<b>H</b>	<p><b>WARNING:</b> This machine contains dust hazardous to health. Emptying and maintenance operations, including removal of the dust collection means, must only be carried out by authorised personnel wearing suitable personal protection. Do not operate without the full filtration system fitted.</p>	<p><b>ACHTUNG:</b> Dieses Gerät enthält gesundheitsschädlichen Staub. Leerungs- und Wartungsvorgänge, einschließlich der Beseitigung der Staubsammelbehälter, dürfen nur von Fachleuten durchgeführt werden, die entsprechende Schutzausrüstung tragen. Nicht ohne das vollständige Filtrationssystem betreiben.</p>	<p><b>VARNING:</b> Denna utrustning innehåller hälsofarligt damm. Tömning och service, inklusive filterbyte, får endast utföras av en fackman med lämplig personlig skyddsutrustning. Får ej användas utan komplett filtersystem.</p>	<b>H</b>
----------	--	--	---	----------

## Données techniques

Données techniques	DC 1800H	DC 1800H XL
HxIxP [mm]	780 x 405 x 390	1225 x 402 x 382
Poids [kg]	14	19
Entrée [mm]	Ø50	Ø50
Longueur du tuyau Ø38 [m]	5	5
Récipient de collecte [l]	20	55
Débit max. [m <sup>3</sup> /h]	205	205
Sous-pression max. [kPa]	24	24
Puissance de sortie [W]	1285 (230 V)	1285 (230 V)
Auto : Puissance outil connecté*/min. 200 W	115/230 V/ 10A: 1340/1285 W 230 V/16 A: 2200 W	115/230 V/10 A: 1340/1285 W 230 V/16 A: 2200 W
Cellulose à filtre fin, surface [m <sup>2</sup> ]	1,5	1,5
Degré de séparation filtre fin, EN 60335-2-69, classe M [%]	99,9	99,9
Surface du filtre filtre HEPA [m <sup>2</sup> ]	0,85	0,85
Degré de séparation machine, EN 60335-2-69, Annexe A-A, Classe H [%]	99,995	99,995
Classification des filtres, EN 1822-1	HEPA H13	HEPA H13
Niveau sonore [dB(A)]	< 66	< 68
IP	44	44

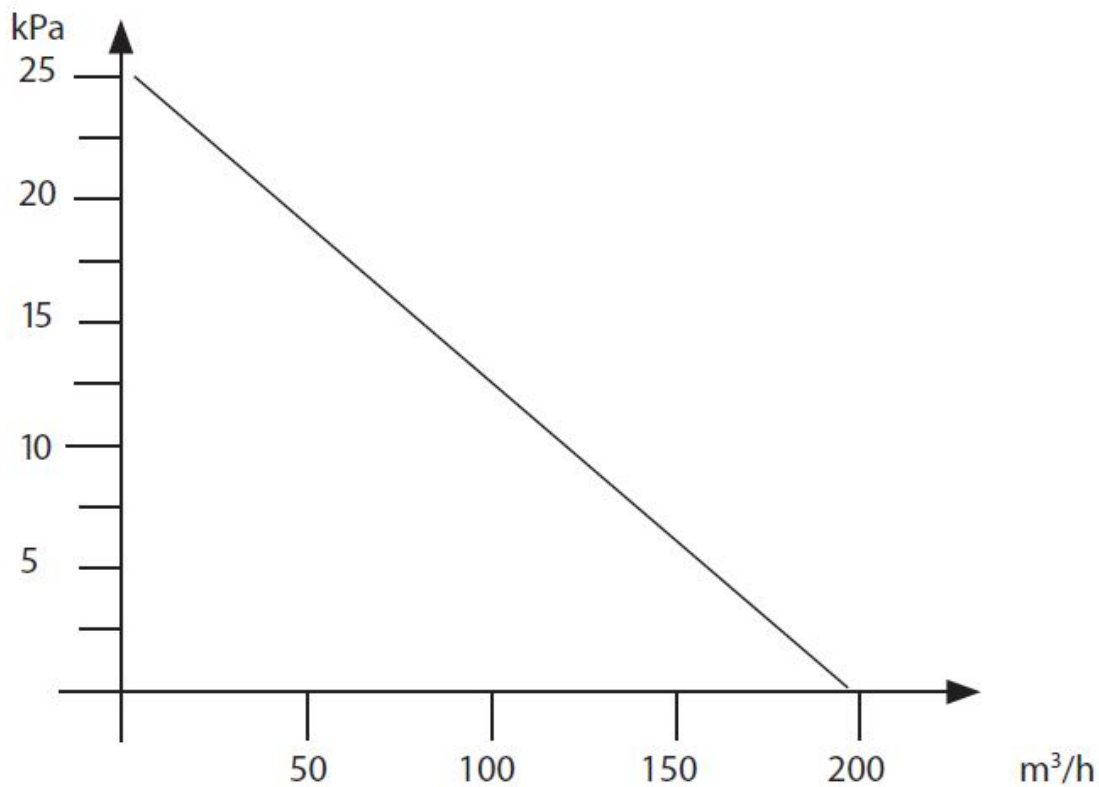

Génération de pression et débit d'air

## Opération

### Branchement

Brancher la machine à une prise électrique conforme aux indications de la plaque signalétique de la machine.

### Démarrage automatique

Brancher l'outil électrique à la prise de la machine. Réglez le commutateur sur la position AUTO. La machine démarre alors automatiquement lorsque l'outil est démarré. La machine s'éteint quelques secondes après la l'arrêt de l'outil. Pour démarrer manuellement l'aspiration, réglez le commutateur sur la position MAN.

### Nettoyage du filtre

La machine est dotée d'un témoin lumineux de filtre qui s'allume lorsque le filtre doit être nettoyé ou remplacé.

Pour nettoyer le filtre :

Pendant le nettoyage du filtre, la machine doit être en marche et le tuyau retiré du tube d'aspiration.

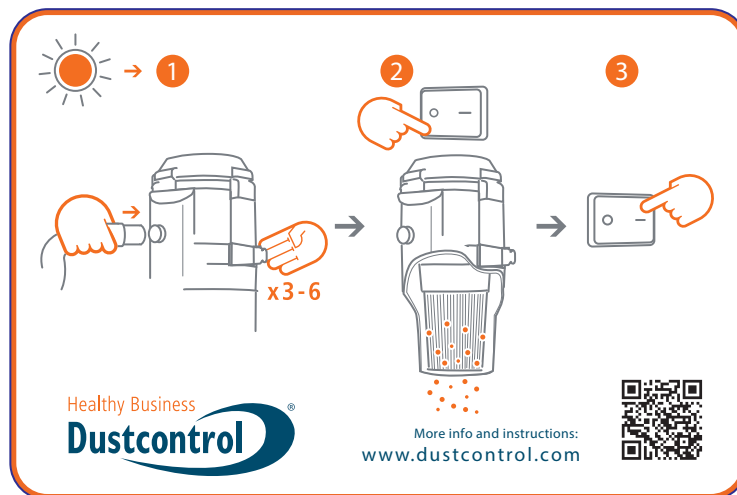

1. Appuyez le manchon de raccordement contre le bouchon noir du conduit d'évacuation ou contre le sol, afin de créer une dépression maximale dans le cyclone. Ouvrez ensuite le rabat sur le côté 3 à 6 fois. L'air circule dans la machine et nettoie le filtre par impulsion.
2. Éteignez la machine et laissez tomber le matériau. Rebranchez le tube d'aspiration.
3. Démarrez la machine.

### Vidange

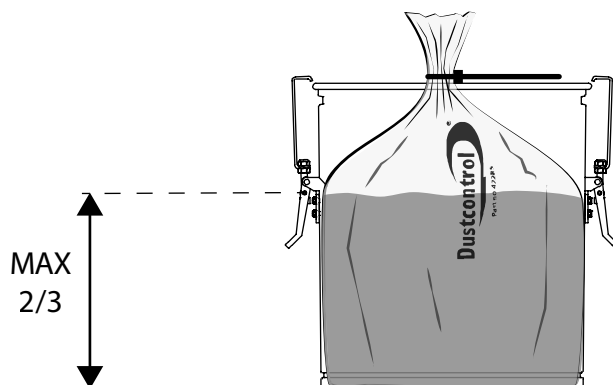

Le récipient sous le cyclone doit être vidé lorsqu'il est rempli aux 2/3 maximum.



## Service et entretien

### Nettoyage

Lors du nettoyage et de l'entretien de la machine, la machine doit être éteinte et la fiche débranchée.

### Remplacement du filtre

Le filtre fin doit être changé au moins une fois par an. Le filtre HEPA doit être remplacé après 300 heures de fonctionnement. Seuls les filtres originaux peuvent être utilisés.



#### AVERTISSEMENT

Le remplacement du filtre ne peut être effectué que par un personnel formé. Utiliser un masque de protection et un équipement approprié.

1. Desserrez et soulevez le couvercle pour accéder librement au filtre. Mettez ensuite un sac en plastique sur le cyclone.
2. Soulevez le filtre directement dans le sac en plastique. Vérifiez ensuite que l'emballage est complet. En cas de dommage, le joint doit être remplacé pour garantir l'étanchéité.
3. Attachez le sac autour du filtre.
4. Jetez le filtre et le sac en plastique de manière appropriée.

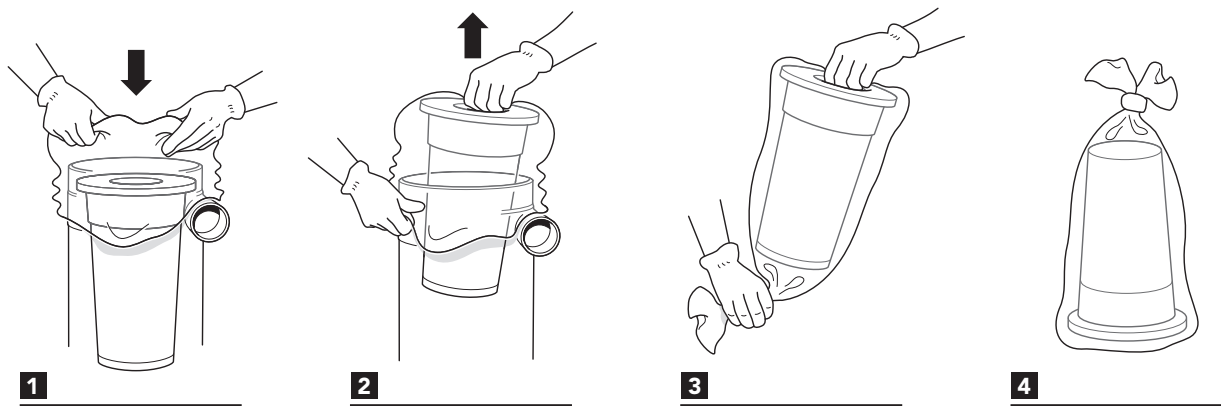

### Moteur

Pour les moteurs à ventilateur, la durée de vie typique des balais d'origine est 600-700 heures. La brosse peut être remplacée. Le deuxième jeu de brosses a une durée de vie d'environ 400 heures et le troisième d'environ 300 heures. Le collecteur est alors usé et le moteur doit être remplacé.

### Contrôle régulier

Contrôler régulièrement que le cordon d'alimentation n'est pas endommagé.

## Consommables & accessoires

Désignation	Réf.
Sac en plastique, standard	42291
Sac en plastique (XL)	42285
Filtre fin en cellulose avec protection de filtre intégrée	42029
Filtre fin PTFE, avec protection de filtre intégrée	42028-02
Filtre HEPA	42027
Panier pour sac en plastique	42369
Tuyau d'aspiration (Ø 38) 5 m	2105 + 2108
Tuyau d'aspiration antistatique (Ø 38) 5 m (XL)	2012 + 2114

## Garantie

La période de garantie est de deux ans et concerne les défauts de fabrication. La garantie s'applique à condition que la machine soit utilisée dans des conditions normales et que l'entretien nécessaire est réalisé. L'usure normale n'est pas couverte par la garantie. Les réparations sont effectuées par Dustcontrol ou par une personne agréée par Dustcontrol. Sinon, la garantie est annulée.

### **Moteur**

Le ou les moteurs du produit ne sont pas couverts par la garantie. La durée de vie d'un moteur peut être comprise entre 600 et 700 heures de fonctionnement. Contactez Dustcontrol si vous devez changer le moteur.

## Recherche de pannes

Problème	Cause	Action
Le moteur ne fonctionne pas.	La machine n'est pas branchée à la prise secteur.	Brancher la machine.
Le moteur s'arrête immédiatement après le démarrage.	Mauvais fusible.	Remplacer par un fusible correct.
Le moteur fonctionne, mais la machine n'aspire pas.	Le tuyau d'aspiration n'est pas raccordé.	Brancher le tuyau.
Le moteur fonctionne, mais la machine n'aspire pas bien.	Tuyau d'aspiration troué.	Changer le tuyau.
	Filtre bouché.	Nettoyer ou remplacer.
	Tuyau d'aspiration trop long ou étroit.	Changer le tuyau.
	Tuyau partiellement bouché.	Retourner le tuyau ou le nettoyer.
	Partie supérieure de la machine mal montée.	Vérifier le montage.
	La poussière est piégée dans le cyclone.	Enlever la partie supérieure et nettoyer le cyclone.
Le moteur s'arrête pendant le fonctionnement.	Le moteur est en surchauffe.	Vérifiez que la machine n'est pas étranglée et attendez que la machine ait refroidi (environ 30 min).
La machine libère de la poussière.	Le filtre est desserré ou cassé.	Vérifier et remplacer si nécessaire.
Bruit anormal de la machine.		Demander l'intervention d'un technicien.

## Déclaration CE

Nous certifions par la présente que le DC 1800 H, Autostart & XL est conforme aux réglementations et normes suivantes :

2006/42/EC, 2014/30/EU, 2014/35/EU, EN 60204-1:2018, EN1822-1:2019.

Dustcontrol AB



**Nina Uggowitzner / CEO & Technical Manager**

**2024-10-18**

## Des pièces de rechange

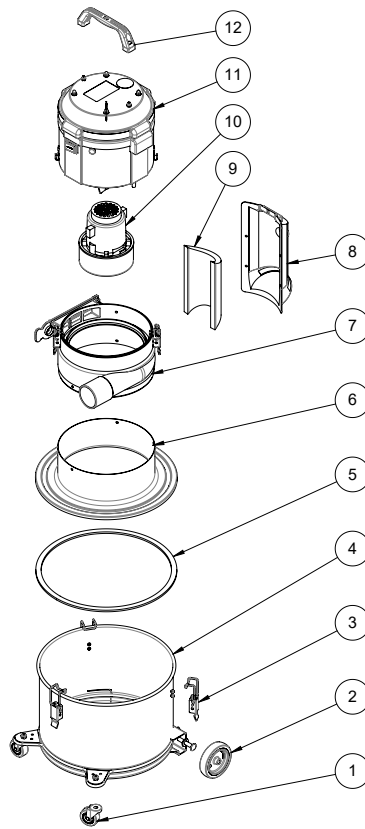

Numéro	N° d'art.	Désignation
1	42308	Roue de liaison D50 H64
2	42307	Roue D100
3	42365	Serrure excentrique
4*	42278-40	Récepteur
	40444-1	Conteneur XL
5	40514	Joint 15x8 Autocollant
6	42276	Cyclone/Casquette
7	940453-70	Module d'entrée
8	42275	Conduit d'échappement
9	42284	Insonorisant
10	41800	Pack moteur Eco 1285W
	41801	Pack moteur Auto Eco 1285W
11	41801-70	Moteur supérieur, DC Auto Eco 1285W
12	426700	Poignée

# Contact

## Dustcontrol Worldwide



**AT**  
Dustcontrol Ges.m.b.H.  
info@dustcontrol.at  
www.dustcontrol.at



**AU**  
All Preparation Equipment  
www.allprep.com.au



**BENELUX**  
Dust Solutions BV  
www.dustsolutions.nl



**BG**  
Metaltech14 Ltd.  
metaltech14@abv.bg  
www.dustcontrolbg.com



**CA** Dustcontrol  
Canada Inc.  
info@dustcontrol.ca  
www.dustcontrol.ca



**CH**  
Rosset Technik Maschinen  
Werkzeuge AG  
www.rosset-technik.ch  
info@rosset-technik.ch



**CL**  
Beckart Tecnologia Ambiental S.A.  
ambitec@ambitec.cl  
www.ambitec.cl



**CN**  
Suzhou Dustcollect Filtration  
Technology Co. Ltd.  
wang@dustcollect.cn  
www.dustcollect.cn



**CZ / SK** Ener  
Group CZ, S.R.O. Infolinka:  
+420 602 795 800  
info@energrou.cz  
www.prumysloveodsavani.cz/



**DE**  
Dustcontrol GmbH  
info@dustcontrol.de  
www.dustcontrol.de



**DK**  
Construction – Erenfred Pedersen A/S  
info@ep.dk  
www.ep.dk  
  
Industry – Dansk Procesventilation ApS  
info@dansk-procesventilation.dk  
www.dansk-procesventilation.dk



**EE**  
G-Color Baltic OÜ  
sales@g-color.ee  
www.g-color.ee



**ES**  
Barin, s.a.  
info@barin.es  
www.barin.es



**GB**  
Dustcontrol UK Ltd.  
sales@dustcontrol.co.uk  
www.dustcontrol.co.uk



**GR**  
Mavrogiannakis S.A  
ekttox@enternet.gr  
www.ekttoxefits.com.gr



**FI**  
Dustcontrol FIN OY  
dc@dustcontrol.fi  
www.dustcontrol.fi



**FR**  
Construction – SMH Equipements  
info@abequipements.com  
www.smhequipements.com



Industry – Dustcontrol AB  
info@dustcontrol.fra  
www.dustcontrol.fra



**HR**  
Kermek d.o.o.  
kruno.nedeljko@kermek.com  
www.kermek.com



**HU**  
Vandras Kft  
vandras@t-online.hu  
www.vandras.hu



**IN**  
Advance Ventilation Pve Ltd.  
sales@advanceventilation.com  
www.advanceventilation.com



**IT**  
Airum srl  
info@airum.com  
www.airum.com



**KR**  
ESH Engineering Co.  
eshengco@gmail.com  
www.eshengco.com



**LT**  
UAB Hidromega  
info@hidromega.lt  
www.hidromega.lt



**LV**  
SIA Reaktivs  
reaktivs@reaktivs.lv  
www.reaktivs.lv



**MY, ID**  
Stada EnviroSpace Bhd  
info@stada.com.my  
www.stada.com.my



**NO**  
Teijo Norge A.S  
firmapost@teijo.no  
www.teijo.no



**NZ**  
Artizan Diamond Tools  
enquiry@artizandiamond.co.nz  
www.artizandiamond.co.nz



**PE**  
Efixo  
contacto@efixo.pe  
www.efixo.pe



**PH**  
Sweden Concrete Machines Inc.  
peringe@packoskick.se  
www.swedenconcretemachines.ph



**PL**  
Bart Sp. z o.o.  
info@bart-vent.pl  
www.bart-vent.pl



**PT**  
Metec-Mecano Técnica, Lda.  
geral@metec.pt  
www.metec.pt



**RO**  
AWS Elektrotehnik  
office@awstehnik.ro  
www.awstehnik.ro

General Contractor Industry SRL  
office@gci-grup.ro  
www.gci-grup.ro



**RS**  
Enel Alati  
eneldoo@eunet.rs  
www.eneldoo.rs



**RU**  
Centre Vacuum System  
panov.g@movers-td.com  
www.dustcontrolrus.ru



**SE**  
Dustcontrol AB  
info@dustcontrol.se  
www.dustcontrol.com



**SG**  
Stada EnviroSpace Pte Ltd  
Info@stada.com.my  
www.stada.com.my



**TW**  
Goodland Enterprise Co., Ltd.  
sales@goodland.com.tw  
www.goodland.com.tw



**TH**  
MCON Intertrade Co., Ltd.  
sales@mconintertrade.com  
www.mconintertrade.com



**TR** Ventek  
Mühendislik Ltd.  
info@ventek.com.tr  
www.ventek.com.tr



**AE**  
Global Enterprises Trading Co L.L.C.  
sales@globalentco.com  
www.globalentco.com



**GEM**  
Industrial Equipment Trading Co. Tel:  
+971 4 8840 474  
Email: gemuae@eim.ae



**UA**  
MBK Obshemashkontrakt, JSC  
zao@omk.dp.ua  
www.omk.dp.ua



**US**  
Dustcontrol Inc.  
info@dustcontrolusa.com  
www.dustcontrol.us



**VN**  
Tayhostar JSC  
tayhostar@tayhostar.vn  
www.tayhostar.vn

Please contact the head office  
in Sweden if you do not find a  
distributor in your area.  
info@dustcontrol.se

## Oikeudellinen huomautus



### HUOMAUTUS

Alkuperäisen käyttöoppaan käännös



### TÄRKEÄÄ

Lue käyttöohje ennen koneen käyttöä.



### TÄRKEÄÄ

Dustcontrol pidättää oikeuden muuttaa teknisiä tietoja ilman erillistä ilmoitusta, eikä sillä ole velvollisuutta muuttaa aiemmin toimitettuja tuotteita. Dustcontrol ei ole vastuussa tämän käyttöoppaan virheistä tai puutteista.



### TÄRKEÄÄ

Kaikkia asiaankuuluvia valtion, alueellisia ja paikallisia turvallisuusmääräyksiä on noudatettava tämän tuotteen asennuksessa ja käytössä. Turvallisuussyistä ja dokumentoitujen järjestelmätietojen noudattamisen varmistamiseksi vain valmistaja saa suorittaa komponenttien korjauksia. Jos näitä tietoja ei noudateta, seurauksena voi olla henkilövahinko tai laitevaurio.



### TÄRKEÄÄ

Kaikki oikeudet pidätetään. Mitään tämän julkaisun osaa ei saa jäljentää, levittää tai välittää missään muodossa tai millään tavalla, mukaan lukien valokopiointi, tallennus tai muut elektroniset tai mekaaniset keinot, ilman julkaisijan etukäteen antamaa kirjallista lupaa. Lupakysymyksiä varten ota yhteyttä Dustcontroliin.



### HUOMAUTUS

Tuotteen valmistaja:

Dustcontrol AB  
Box 3088, Kumla Gårdsväg 14  
SE-145 03 Norsborg  
Tel: +46 8 531 940 00  
support@dustcontrol.se  
www.dustcontrol.com



## Turvallisuusmääräykset

### Johdanto

Lue seuraavat turvallisuusohjeet ennen tämän koneen käynnistämistä. Säilytä käyttöohje. Jos turvallisuusmääräyksiä ei noudateta, takuu ei ole voimassa. Myös henkilö- ja tuotevaurioita voi tapahtua. Dustcontrol ei ole vastuussa virheellisestä asennuksesta tai laitteen väärästä käsittelystä aiheutuneista laitteille aiheutuneista vaurioista.

### Varoitus

Tämä kone on tarkoitettu vain ammattikäyttöön.

Lapsia on valvottava sen varmistamiseksi, etteivät he leiki koneella.

Käytä vain alkuperäisiä lisävarusteita ja kulutustarvikkeita, jotka sisältyvät Dustcontrolin valikoimaan.



#### VAROITUS

Käytä konetta vain sen käyttötarkoitukseen. Noudata imettävänä olevaa materiaalia koskevia ohjeita.



#### VAROITUS

Tämä kone on tarkoitettu vain kuivan materiaalin imemiseen.



#### VAROITUS

Sähkölaitteiden käytössä on noudatettava tärkeitä turvallisuusohjeita tulipalon, sähköiskun tai henkilövahinkojen välttämiseksi.



#### VAROITUS

Koneeseen ei saa imeä kuumia tai hehkuvia hiukkasia eikä muita syttymislähteitä. Konetta ei saa käyttää räjähtäville, epästabiileille eikä itsestään syttyville hiukkasille.



#### VAROITUS

Käytettäessä väärä tuotteita tai kopioita (varsinkin suodattimia, letkuja ja muovisäkkejä) voi kone vuotaa hengenvaarallista pölyä, joka vahingoittaa terveyttä.

### Ympäristönsuojelu

Kierrätä pakkaus ja mukana tulevat komponentit paikallisten määräysten mukaisesti. Lisätietoja saat lähimmältä kierrätyskeskukselta tai Dustcontrolilta koneen romuttamista varten.

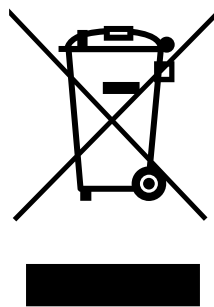
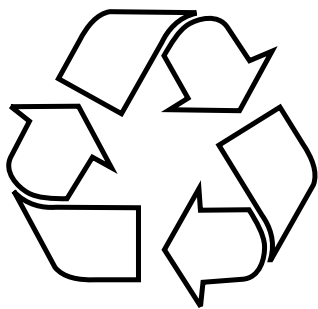

### WEEE (Waste of Electric and Electronic Equipment)

Koskee vain EU-maita: Sähkölaitteita ei saa hävittää kotitalousjätteen mukana. Sähkö- ja elektroniikkalaiteromusta annetun direktiivin 2002/96/EY ja sen kansallisessa lainsäädännössä soveltamista koskevien määräysten mukaisesti on käytetyt sähkötyökalut lajiteltava erikseen ja toimitettava kierrätettäviksi ympäristöystävällisellä tavalla.

### Työympäristö

Älä altista konetta kastumiselle. Älä käytä sitä kosteissa tai märissä tiloissa eikä helposti syttyvien nesteiden tai kaasujen lähellä.



#### VARO

Tätä konetta saa käyttää ja säilyttää vain kuivissa ympäristöissä.



#### VARO

Konetta ei saa huuhdella vedellä.

### Ylikuormitus



#### VARO

Älä anna koneen koskaan toimia täysin kuristettuna, sillä se aiheuttaa ylikuormitusvaaran.

### Ruumiinvammat



#### VAROITUS

Älä koskaan yritä itse muuttaa sähköliitäntöjä. Virhe voi olla hengenvaarallinen!



#### VAROITUS

Älä koskaan anna imukohdan koskettaa mitään kehonosaa. Voimakas alipaine voi vahingoittaa ihon verisuonistoa.



### **VAROITUS**

Tuotetta asennettaessa, käsiteltäessä ja kuljettaessa on käytettävä suojakäsineitä.

## **Sähkökaapeli**



### **VAROITUS**

Älä koskaan vedä konetta virtajohtosta. Älä altista virtajohtoa lämmölle tai teräville esineille. Tarkasta virtajohto säännöllisin väliajoin.

Jatkettaessa virtajohtoa on jatkojohdon oltava kosteussuojattu.

Koetta ei saa käyttää, jos sähkökaapelit tai liittimet ovat vahingoittuneet.

Jos virtajohto on vahingoittunut, Dustcontrolin tai Dustcontrolin valtuuttaman huoltoliikkeen on annettava vaihtaa se.

## **Tärkeä toimenpide**

Katkaise virta pääkatkaisimesta ja irrota kone sähköverkosta ennen koneen puhdistamista tai huoltamista.

Tätä konetta saa käyttää vain, jos kaikki suodattimet ovat ehjät ja oikein asennettu.

## **Hoito**

Pidä kone puhtaana ja vapaana pöykerrostumista. Varmista, että imuletku on ehjä ja kaikki tiivisteet ovat vahingoittumattomia ja kunnossa. Pidä kahvat kuivina sekä öljyttöminä ja rasvattomina.

## **Ohjaus**

Tarkasta säännöllisesti, että laitteessa ei ole vaurioita eikä kulumia. Jos vaurioita syntyy, ne on korjautettava Dustcontrolin huoltoteknikolla tai Dustcontrolin hyväksymässä huoltoliikkeessä.

## Toimintakuvaus

Pölynkerääjä toimii alipaineella (imu), joka ohjaa ilman imukuvun/suuttimen, letkujärjestelmän sekä esi- ja pölynerottimen läpi. Karkeaerottelu tapahtuu yksikön syklonissa, mikä on erittäin tehokas yhä karkeamman pölyn erottelu. Hieno pöly erotetaan laitteen suodattimesta. Suodattimen puhdistus ilmapulssilla antaa suodattimille erityisen pitkän käyttöiän. Kone on varustettu HEPA-suodattimilla.

Pölynerotin on luotettava ja kestävä. Se sopii erityisesti kuivan, terveydelle haitallisen ja syttymättömän H-pölyluokkaan kuuluvan pölyn sekä pölyn, jolle on määritetty altistumisen raja-arvot, ja saksalaisen vaarallisia aineita koskevan GefStoffV-asetuksen mukaan karsinogeenisia aineita sisältävän pölyn imurointiin ja poistamiseen.

<b>H</b>	<p><b>WARNING:</b> This machine contains dust hazardous to health. Emptying and maintenance operations, including removal of the dust collection means, must only be carried out by authorised personnel wearing suitable personal protection. Do not operate without the full filtration system fitted.</p>	<p><b>ACHTUNG:</b> Dieses Gerät enthält gesundheitsschädlichen Staub. Leerungs- und Wartungsvorgänge, einschließlich der Beseitigung der Staubsammelbehälter, dürfen nur von Fachleuten durchgeführt werden, die entsprechende Schutzausrüstung tragen. Nicht ohne das vollständige Filtrationssystem betreiben.</p>	<p><b>VARNING:</b> Denna utrustning innehåller hälsofarligt damm. Tömning och service, inklusive filterbyte, får endast utföras av en fackman med lämplig personlig skyddsutrustning. Får ej användas utan komplett filtersystem.</p>	<b>H</b>
----------	--	--	---	----------

## Tekniset tiedot

Tekniset tiedot	DC 1800H	DC 1800H XL
KxLxS [mm]	780 x 405 x 390	1225 x 402 x 382
Paino [kg]	14	19
Tulo [mm]	Ø50	Ø50
Letkun pituus Ø38 [m]	5	5
Keruuastia [l]	20	55
Virtaus maks. [m <sup>3</sup> /h]	205	205
Alipaine maks. [kPa]	24	24
Teho [W]	1285 (230 V)	1285 (230 V)
Auto: Kytkeytyn työkalun teho*/min 200 W	115/230 V/ 10A: 1340/1285 W	115/230 V/10 A: 1340/1285 W
	230 V/16 A: 2200 W	230 V/16 A: 2200 W
Hienosuodattinselluloosa, pinta-ala [m <sup>2</sup> ]	1,5	1,5
Hienosuodattimen suodatusaste, EN 60335-2-69, luokka M [%]	99,9	99,9
Suodattimen pinta HEPA-suodatin [m <sup>2</sup> ]	0,85	0,85
Koneen suodatusaste, EN 60335-2-69, liite A-A, luokka H [%]	99,995	99,995
Suodatinluokka, EN 1822-1	HEPA H13	HEPA H13
Äänitaso [dB(A)]	< 66	< 68
IP	44	44

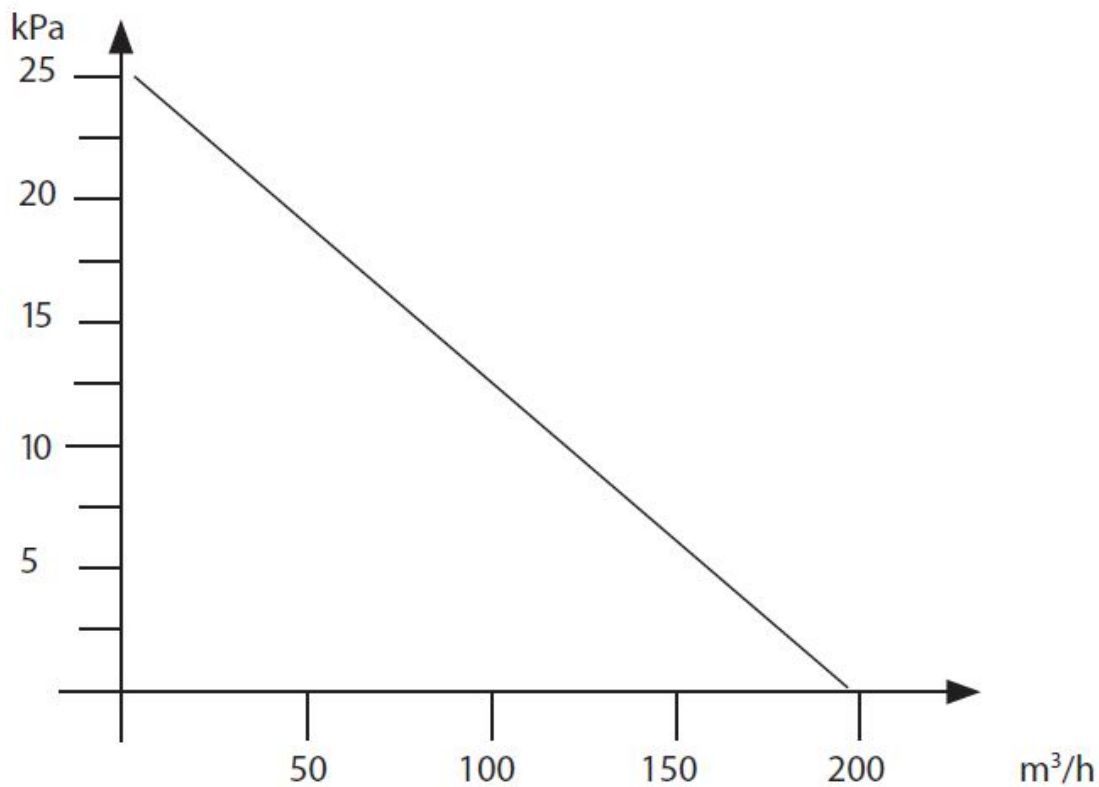

Paineen muodostus ja ilmavirta

## Toiminta

### Kytkeminen

Kytke kone pistorasiaan, jonka jännite vastaa koneen tyyppikilvessä annettuja tietoja.

### Automaattinen käynnistys

Kytke sähkölaite koneessa olevaan pistorasiaan. Aseta kytkin asentoon AUTO. Kone käynnistyy silloin automaattisesti, kun sähkölaite käynnistetään. Kone sammuu pari sekuntia sen jälkeen, kun siihen kytketty sähkölaite sammutetaan. Imun käynnistämiseksi manuaalisesti aseta kytkin asentoon MAN.

### Suodattimen puhdistus

Koneessa on suodattimen merkkivalo, joka syttyy, kun suodatin on puhdistettava tai vaihdettava.

Suodatin puhdistetaan näin:

Suodatinta puhdistettaessa koneen on oltava käynnissä, ja letku irrotetaan imuputkesta.

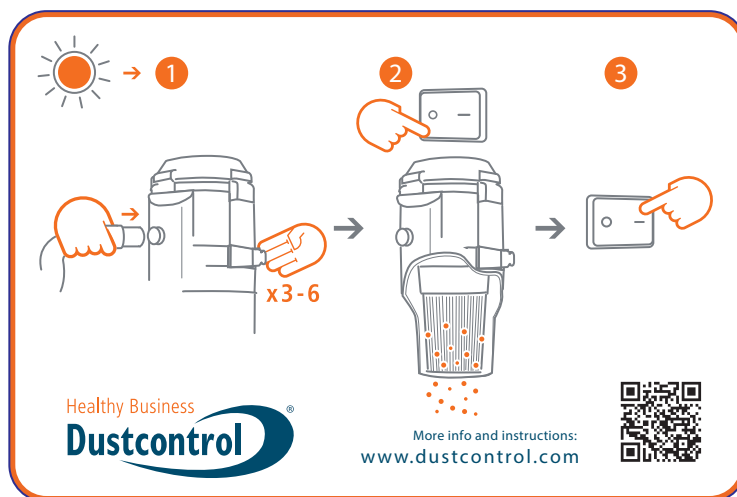

1. Paina liitäntäholkki mustaa tulppaa vasten poistokanavassa tai lattiaa vasten, jotta syklonissa syntyy maksimialipaine. Avaa sitten läppä sivulta 3-6 kertaa. Ilma virtaa koneeseen ja puhdistaa suodattimen pulssitoiminnolla.
2. Sammuta kone ja anna materiaalin pudota alas. Liitä imuputki takaisin.
3. Käynnistä kone.

### Tyhjennys

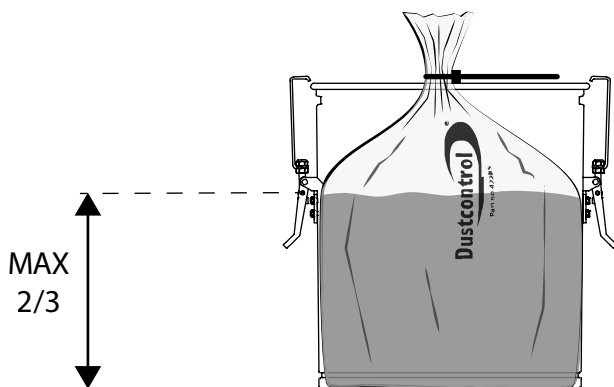

Syklonin alla oleva säiliö tulee tyhjentää, kun se on täytetty enintään 2/3.

## Huolto & huolto

### Puhdistus

Koneen puhdistuksen ja huollon aikana kone on sammutettava ja pistoke irrotettava.

### Suodattimen vaihto

Hienosuodatin on vaihdettava vähintään kerran vuodessa. HEPA-suodatin on vaihdettava 300 käyttötunnin jälkeen. Vain alkuperäisiä suodattimia saa käyttää.



#### VAROITUS

Suodattimen saa vaihtaa vain koulutettu työntekijä. Käytä hengityssuojainta ja asianmukaisia varusteita.

1. Löysää ja nosta kansi pois päästäksesi vapaasti käsiksi suodattimeen. Laita sitten muovipussi syklonin päälle.
2. Nosta suodatin suoraan ylöspäin muovipussiin. Tarkista sitten, että pakkaus on valmis. Vahingon sattuessa tiiviste on vaihdettava tiiviyden varmistamiseksi.
3. Sido pussi suodattimen ympärille.
4. Hävitä suodatin ja muovipussi asianmukaisesti.

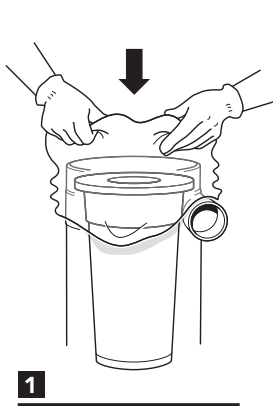

1



2



3



4

### Moottori

Puhallinmoottoreiden tyypillinen käyttöaika on 600-700 tuntia. Harja on mahdollista vaihtaa. Toisen harjapaketin käyttöaika on noin 400 tuntia, ja kolmannen harjapaketin noin 300 tuntia. Tämän jälkeen kollektori on kulunut loppuun ja moottori on vaihdettava.

### Säännöllinen tarkastus

Tarkasta virtajohto säännöllisesti vaurioitten varalta.

## Kulutustarvikkeet ja tarvikkeet

Nimitys	Tuotenro
Muovisäkki, vakio	42291
Muovisäkki (XL)	42285
Hienosuodatin selluloosaa, integroitu suodattimensuojus	42029
Hienosuodatin PTFE, integroidulla suodatinsuojalla	42028-02
HEPA-suodatin	42027
Kori muovisäkillä	42369
Imuletku (Ø 38) 5 m	2105 + 2108
Antistaattinen imuletku (Ø 38) 5 m (XL)	2012 + 2114



## Takuu

Takuuaika on kaksi vuotta ja koskee valmistusvirheitä. Takuun voimassaolo edellyttää, että konetta käytetään normaalilla tavalla ja sitä huolletaan vaatimusten mukaisesti. Normaalista kulumista ei korvata. Korjaukset on teetettävä Dustcontrolilla tai Dustcontrolin hyväksymällä henkilöllä. Muussa tapauksessa takuu raukeaa.

## Moottori

Tuotteen moottori(t) eivät kuulu takuun piiriin. Moottorin näytteen käyttöikä voi olla 600 - 700 käyttötuntia. Ota yhteyttä Dustcontroliin, jos sinun on vaihdettava moottori.

## Vianmääritys

Ongelma	Syy	Toimenpide
Moottori ei käy.	Sähkö ei ole kytkettynä.	Kytke sähkö.
Moottori pysähtyy heti käynnistyksen jälkeen.	Vääränlainen sulake.	Vaihda oikea sulake.
Moottori käy mutta kone ei ime.	Imuletku ei ole kytkettynä.	Kytke letku.
Moottori käy mutta kone imee huonosti.	Imuletkussa on reikä.	Vaihda letku.
	Suodatin on tukkeutunut.	Puhdista tai vaihda.
	Imuletku on liian pitkä tai kapea.	Vaihda letku.
	Letku on osittain tukossa.	Käännä letkua tai puhdista se.
	Koneen yläosa on huonosti kiinnitetty.	Korjaa kiinnitystä.
	Sykloniin on takertunut pölyä.	Irrota yläosa ja puhdista sykloni.
Moottori pysähtyy käytön aikana.	Moottori on ylikuumentunut.	Tarkista, että kone ei ole kuristettu ja odota, kunnes kone on jäähtynyt (n. 30 min).
Kone puhaltaa ulos pölyä.	Suodatin on löystynyt tai rikkoutunut.	Tarkasta ja vaihda tarvittaessa.
Koneesta kuuluu epänormaalia ääntä.		Tilaa huolto.

## EY-vaatimustenmukaisuusvakuutus

Täten vakuutamme, että DC 1800 H, Autostart & XL on seuraavien määräysten ja standardien mukainen:

2006/42/EC, 2014/30/EU, 2014/35/EU, EN 60204-1:2018, EN1822-1:2019.

Dustcontrol AB



**Nina Uggowitzner / CEO & Technical Manager**

**2024-10-18**

# Varaosat

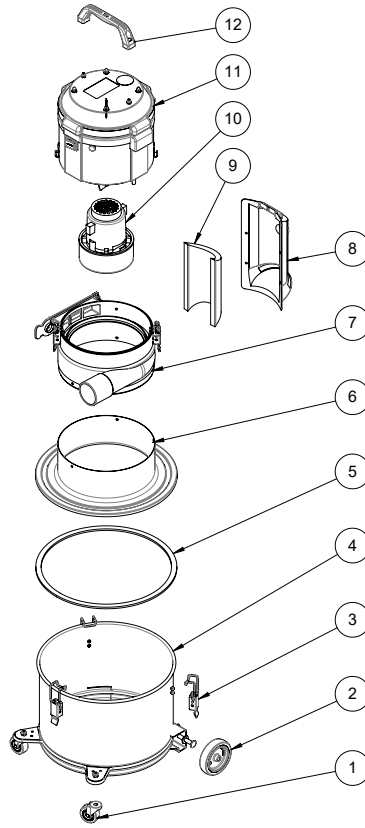

Numero	Tuotenro	Nimitys
1	42308	Linkkipyörä D50 H64
2	42307	Pyörä D100
3	42365	Eksentrisen lukko
4*	42278-40	Säiliö
	40444-1	Säiliö XL
5	40514	Tiiviste 15x8 Itseliimautuva
6	42276	Sykloni/Cap
7	940453-70	Tulomoduli
8	42275	Poistoputki
9	42284	Ääntä vaimentava
10	41800	Moottoripaketti Eco 1285W
	41801	Moottoripaketti Auto Eco 1285W
11	41801-70	Moottorin yläosa, DC Auto Eco 1285W
12	426700	Kahva

## Ota yhteyttä

## Dustcontrol Worldwide



AT  
Dustcontrol Ges.m.b.H.  
info@dustcontrol.at  
www.dustcontrol.at



AU  
All Preparation Equipment  
www.allprep.com.au



BENELUX  
Dust Solutions BV  
www.dustsolutions.nl



BG  
Metaltech14 Ltd.  
metaltech14@abv.bg  
www.dustcontrolbg.com



CA Dustcontrol  
Canada Inc.  
info@dustcontrol.ca  
www.dustcontrol.ca



CH  
Rosset Technik Maschinen  
Werkzeuge AG  
info@rosset-technik.ch  
www.rosset-technik.ch



CL  
Beckart Tecnologia Ambiental S.A.  
ambitec@ambitec.cl  
www.ambitec.cl



CN  
Suzhou Dustcollect Filtration  
Technology Co. Ltd.  
wang@dustcollect.cn  
www.dustcollect.cn



CZ / SK Ener  
Group CZ, S.R.O. Infolinka:  
+420 602 795 800  
info@energrou.cz  
www.prumysloveodsavani.cz/



DE  
Dustcontrol GmbH  
info@dustcontrol.de  
www.dustcontrol.de



DK  
Construction – Erenfred Pedersen A/S  
info@ep.dk  
www.ep.dk  
  
Industry – Dansk Procesventilation ApS  
info@dansk-procesventilation.dk  
www.dansk-procesventilation.dk



EE  
G-Color Baltic OÜ  
sales@g-color.ee  
www.g-color.ee



ES  
Barin, s.a.  
info@barin.es  
www.barin.es



GB  
Dustcontrol UK Ltd.  
sales@dustcontrol.co.uk  
www.dustcontrol.co.uk



GR  
Mavrogiannakis S.A  
ekttox@enternet.gr  
www.ekttoxefits.com.gr



FI  
Dustcontrol FIN OY  
dc@dustcontrol.fi  
www.dustcontrol.fi



FR  
Construction – SMH Equipements  
info@abequipements.com  
www.smhequipements.com



Industry – Dustcontrol AB  
info@dustcontrol.fra  
www.dustcontrol.fra



HR  
Kermek d.o.o.  
kruno.nedeljko@kermek.com  
www.kermek.com



HU  
Vandras Kft  
vandras@t-online.hu  
www.vandras.hu



IN  
Advance Ventilation Pve Ltd.  
sales@advanceventilation.com  
www.advanceventilation.com



IT  
Airum srl  
info@airum.com  
www.airum.com



KR  
ESH Engineering Co.  
eshengco@gmail.com  
www.eshengco.com



LT  
UAB Hidromega  
info@hidromega.lt  
www.hidromega.lt



LV  
SIA Reaktivs  
reaktivs@reaktivs.lv  
www.reaktivs.lv



MY, ID  
Städa Enviroospace Bhd  
info@stada.com.my  
www.stada.com.my



NO  
Teijo Norge A.S  
firmapost@teijo.no  
www.teijo.no



NZ  
Artizan Diamond Tools  
enquiry@artizandiamond.co.nz  
www.artizandiamond.co.nz



PE  
Efixo  
contacto@efixo.pe  
www.efixo.pe



PH  
Sweden Concrete Machines Inc.  
peringe@packoskick.se  
www.swedenconcretemachines.ph



PL  
Bart Sp. z o.o.  
info@bart-vent.pl  
www.bart-vent.pl



PT  
Metec-Mecano Técnica, Lda.  
geral@metec.pt  
www.metec.pt



RO  
AWS Elektrotehnik  
office@awstehnik.ro  
www.awstehnik.ro

General Contractor Industry SRL  
office@gci-grup.ro  
www.gci-grup.ro



RS  
Enel Alati  
eneldoo@eunet.rs  
www.eneldoo.rs



RU  
Centre Vacuum System  
panov.g@movers-td.com  
www.dustcontrolrus.ru



SE  
Dustcontrol AB  
info@dustcontrol.se  
www.dustcontrol.com



SG  
Städa Enviroospace Pte Ltd  
Info@stada.com.my  
www.stada.com.my



TW  
Goodland Enterprise Co., Ltd.  
sales@goodland.com.tw  
www.goodland.com.tw



TH  
MCON Intertrade Co., Ltd.  
sales@mconintertrade.com  
www.mconintertrade.com



TR Ventek  
Mühendislik Ltd.  
info@ventek.com.tr  
www.ventek.com.tr



AE  
Global Enterprises Trading Co L.L.C.  
sales@globalentco.com  
www.globalentco.com



GEM  
Industrial Equipment Trading Co. Tel:  
+971 4 8840 474  
Email: gemuae@eim.ae



UA  
MBK Obshemashkontrakt, JSC  
zao@omk.dp.ua  
www.omk.dp.ua



US  
Dustcontrol Inc.  
info@dustcontrolusa.com  
www.dustcontrol.us



VN  
Tayhostar JSC  
tayhostar@tayhostar.vn  
www.tayhostar.vn

Please contact the head office  
in Sweden if you do not find a  
distributor in your area.  
info@dustcontrol.se

## Juridisk varsel



### NOTAT

Oversettelse av den originale brukerhåndboken



### VIKTIG

Les bruksanvisningen før du bruker maskinen.



### VIKTIG

Dustcontrol forbeholder seg retten til å endre spesifikasjoner uten varsel og er ikke forpliktet til å endre tidligere leverte produkter. Dustcontrol er ikke ansvarlig for feil eller mangler i denne brukerhåndboken.



### VIKTIG

Alle relevante statlige, regionale og lokale sikkerhetsforskrifter må følges når du installerer og bruker dette produktet. Av sikkerhetsgrunner og for å sikre samsvar med dokumenterte systemdata, er det kun produsenten som skal utføre komponentreparasjoner. Unnlattelse av å følge denne informasjonen kan føre til personskade eller skade på utstyr.



### VIKTIG

Alle rettigheter forbeholdt. Ingen del av denne publikasjonen kan reproduseres, distribueres eller overføres i noen form eller på noen måte, inkludert fotokopiering, opptak eller andre elektroniske eller mekaniske midler, uten skriftlig forhåndstillatelse fra utgiveren. For spørsmål om tillatelse, kontakt Dustcontrol.



### NOTAT

Produktet er produsert av:

Dustcontrol AB  
Box 3088, Kumla Gårdsväg 14  
SE-145 03 Norsborg  
Tel: +46 8 531 940 00  
support@dustcontrol.se  
www.dustcontrol.com

## Sikkerhetsforskrifter

### Intro

Les følgende sikkerhetsinstruksjoner før du starter denne maskinen. Lagre bruksanvisningen. Dersom sikkerhetsforskriftene ikke følges, gjelder ikke garantien. Person- og produktskade kan også oppstå. Dustcontrol er ikke ansvarlig for skade på utstyret forårsaket av feil installasjon eller feil håndtering av utstyret.

### Advarsel

Denne maskinen er kun beregnet for profesjonell bruk.

Barn må være under tilsyn for å sikre at de ikke leker med maskinen.

Bruk kun originalt tilbehør og forbruksvarer som er inkludert i Dustcontrols sortiment.



#### ADVARSEL

Bruk maskinen til de oppgavene den er konstruert for. Følg forskriftene for materialet som skal suges opp.



#### ADVARSEL

Denne maskinen skal kun brukes til å suge opp tørt materiale.



#### ADVARSEL

Ved bruk av elektriske enheter må man følge grunnleggende sikkerhetsforskrifter for å redusere risikoen for brann, elektrisk støt og personskade.



#### ADVARSEL

Det må ikke suges varme, glødende partikler eller andre antenningskilder inn i maskinen. Maskinen må ikke brukes til eksplosive, ustabile eller selvantennende partikler.



#### ADVARSEL

Ved bruk av feil artikler eller kopier (først og fremst filtre, slanger og plastsekker), kan maskinen lekke helseskadelig støv, noe som kan føre til personskader.

### Miljøvern

Resirkuler emballasje og inkluderte komponenter i henhold til lokale forskrifter. For mer informasjon, kontakt din nærmeste gjenvinningsstasjon eller Dustcontrol for maskinskrotning.

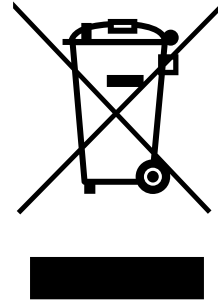
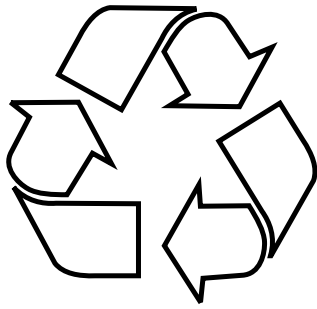

### WEEE (Waste of Electric and Electronic Equipment)

Gjelder bare i EU-land: Elektrisk verktøy skal ikke kastes i husholdningsavfallet. Ifølge direktivet 2002/96/EF, som gjelder eldre elektrisk og elektronisk utstyr og deres bruk i samsvar med nasjonal lovgivning, skal brukt elektrisk verktøy sorteres separat og leveres til gjenvinning.

### Arbeidsmiljø

Ikke utsett maskinen for fuktighet. Den må ikke brukes på fuktige og våte steder, eller i nærheten av lettantennelige væsker eller gasser.



#### OBS

Maskinen skal kun brukes og oppbevares i tørt miljø.



#### OBS

Maskinen skal ikke skylles med vann.

### Overbelastning



#### OBS

Ikke la maskinen arbeide strypt. Det medfører risiko for overoppheting.

### Kroppsskader



#### ADVARSEL

Du må aldri forsøke å endre elektriske koblinger selv. Feil kan føre til livsfare.



#### ADVARSEL

Ikke la sugepunktene komme i kontakt med kroppsdeler. Det kraftige undertrykket kan skade hudens blodkar.





### ADVARSEL

Bruk hansker ved montering, håndtering og transport av produktet.

## Elektrisk kabel



### ADVARSEL

Ikke dra maskinen etter strømledningen. Ikke utsett strømledningen for varme eller skarpe gjenstander. Kontroller strømledningen regelmessig.

Ved skjøting av strømledningen må skjøteledningen være vanntett.

Maskinen skal ikke brukes hvis strømledningene eller kontaktene er skadet.

Hvis strømledningen er skadet, må den byttes av Dustcontrol eller ett av Dustcontrols godkjente serviceverksteder.

## Viktig handling

Før du rengjør eller utfører vedlikehold på maskinen, må du slå av hovedstrømbryteren og koble maskinen fra strømmettet.

Denne maskinen må kun brukes hvis alle filtre er uskadde og riktig montert.

## Omsorg

Hold maskinen ren og fri fra støvbelegg. Påse at sugeslangen er hel, og at alle tetninger er hele og uten feil. Hold bærehåndtakene tørre og fri for olje og fett.

## Kontroll

Kontroller regelmessig at enheten ikke er skadet eller slitt. Hvis det oppstår skader, skal de repareres av Dustcontrols servicetekniker eller av et verksted som Dustcontrol har godkjent.

## Funksjonsbeskrivelse

Støvsamleren jobber med undertrykk (sug) som driver luften gjennom sugehette/dyse, slangesystem og for- og støvutskiller. Grovseparasjon skjer i enhetens syklon, som er en meget effektiv separering av stadig grovere støv. Finstøvet separeres i enhetens filter. Filterrens med luftpuls gir filterne ekstra lang levetid. Maskinen er utstyrt med HEPA-filtre.

Støvsugeren er driftssikker og robust. Den er spesielt velegnet for oppsuging og fjerning av tørt, helseskadelig og ikke-brennbar materiale i klasse H, samt støv med ELV og støv med kreftfremkallende stoffer i samsvar med GetStoffV (German Hazardous Substances Ordinance).

<b>H</b>	<p><b>WARNING:</b> This machine contains dust hazardous to health. Emptying and maintenance operations, including removal of the dust collection means, must only be carried out by authorised personnel wearing suitable personal protection. Do not operate without the full filtration system fitted.</p>	<p><b>ACHTUNG:</b> Dieses Gerät enthält gesundheitsschädlichen Staub. Leerungs- und Wartungsvorgänge, einschließlich der Beseitigung der Staubsammelbehälter, dürfen nur von Fachleuten durchgeführt werden, die entsprechende Schutzausrüstung tragen. Nicht ohne das vollständige Filtrationssystem betreiben.</p>	<p><b>VARNING:</b> Denna utrustning innehåller hälsofarligt damm. Tömning och service, inklusive filterbyte, får endast utföras av en fackman med lämplig personlig skyddsutrustning. Får ej användas utan komplett filtersystem.</p>	<b>H</b>
----------	--	--	---	----------

## Tekniske data

Tekniske data	DC 1800H	DC 1800H XL
H x B x D [mm]	780 x 405 x 390	1225 x 402 x 382
Vekt [kg]	14	19
Innløp [mm]	Ø50	Ø50
Slangelengde Ø38 [m]	5	5
Oppsamlingsbeholder [l]	20	55
Maks. flyt [m <sup>3</sup> /h]	205	205
Undertrykk maks. [kPa]	24	24
Effektuttak [W]	1285 (230 V)	1285 (230 V)
Auto: Effekt, tilkoblet verktøy*/min 200 W	115/230 V/ 10A: 1340/1285 W	115/230 V/10 A: 1340/1285 W
	230 V/16 A: 2200 W	230 V/16 A: 2200 W
Finfiltercellulose, areal [m <sup>2</sup> ]	1,5	1,5
Utskillingegrad finfilter, EN 60335-2-69, klasse M [%]	99,9	99,9
Filteroverflate HEPA-filter [m <sup>2</sup> ]	0,85	0,85
Utskillingegrad maskin, EN 60335-2-69, vedlegg A-A, klasse H [%]	99,995	99,995
Filterklassifisering, EN 1822-1	HEPA H13	HEPA H13
Lydnivå [dB(A)]	< 66	< 68
IP	44	44

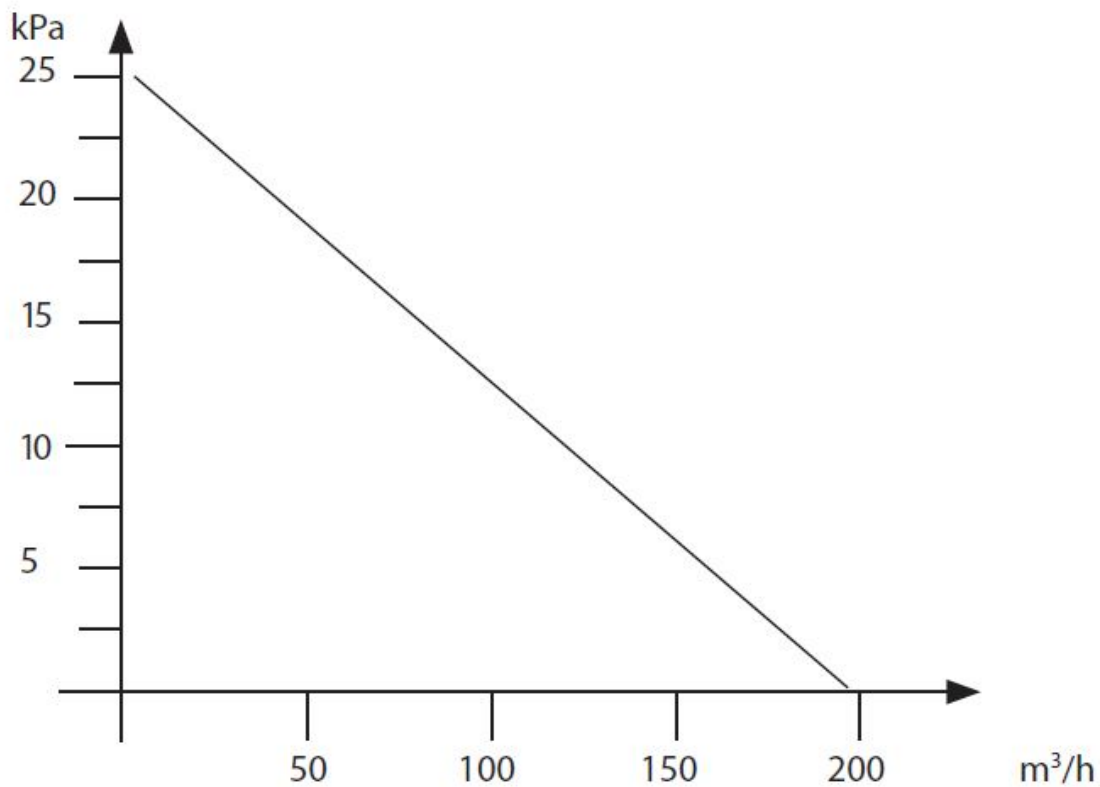

Trykkgenerering og luftstrøm

## Operasjon

### Tilkobling

Koble maskinen til en stikkontakt med spenning som tilsvarer spesifikasjonene på maskinens merkeplate.

### Autostart

Koble elektrisk verktøy til stikkontakten på maskinen. Vri bryteren til AUTO. Maskinen starter automatisk når verktøyet startes. Maskinen stoppes et par sekunder etter at det tilkoblede verktøyet stoppes. Vri bryteren til MAN for å starte sugingen manuelt.

### Filterrensing

Maskinen har en filterindikatorlampe som lyser når filteret må renses eller byttes.

Slik rengjør du filteret:

Ved filterrensing skal maskinen være i drift, og slangen skal løsnes fra røret.

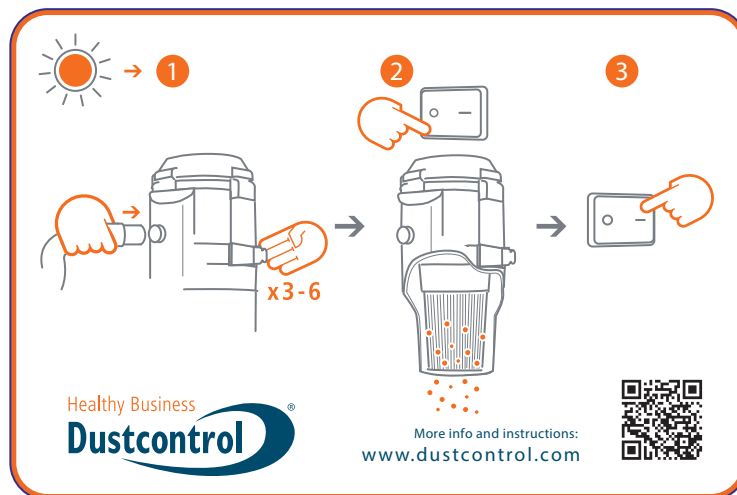

1. Press koblingshylsen mot den svarte stopperen på avtrekkskanalen eller mot gulvet, slik at det skapes maksimalt undertrykk i syklonen. Åpne deretter klaffen på siden 3-6 ganger. Luften strømmer inn i maskinen og renses filteret med pulsvirkningen.
2. Slå av maskinen og la materialet falle ned. Koble til sugeslangen igjen.
3. Start maskinen.

### Tømming

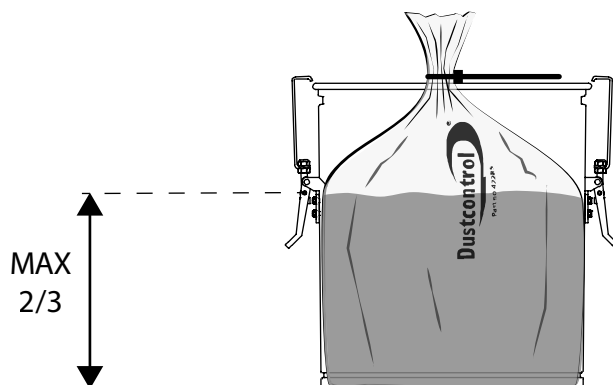

Beholderen under syklonen bør tømmes når den er fylt til maksimalt 2/3.

## Service og vedlikehold

### Rengjøring

Ved rengjøring og vedlikehold av maskinen må maskinen slås av og støpselet trekkes ut.

### Filterbytte

Finfilteret må skiftes minst en gang i året. HEPA-filteret må skiftes etter 300 driftstimer. Kun originale filtre kan brukes.



#### ADVARSEL

Filterbytte skal kun utføres av personell som har fått instruksjoner i hvordan det skal gjøres. Bruk maske og egnet utstyr.

1. Løsne og løft av dekselet for å få fri tilgang til filteret. Legg så en plastpose over syklonen.
2. Løft filteret rett opp i plastposen. Sjekk deretter at pakningen er komplett. Ved skade må pakningen skiftes for å sikre tetthet.
3. Knyt sekken rundt filteret.
4. Kast filteret og plastposen på riktig måte.

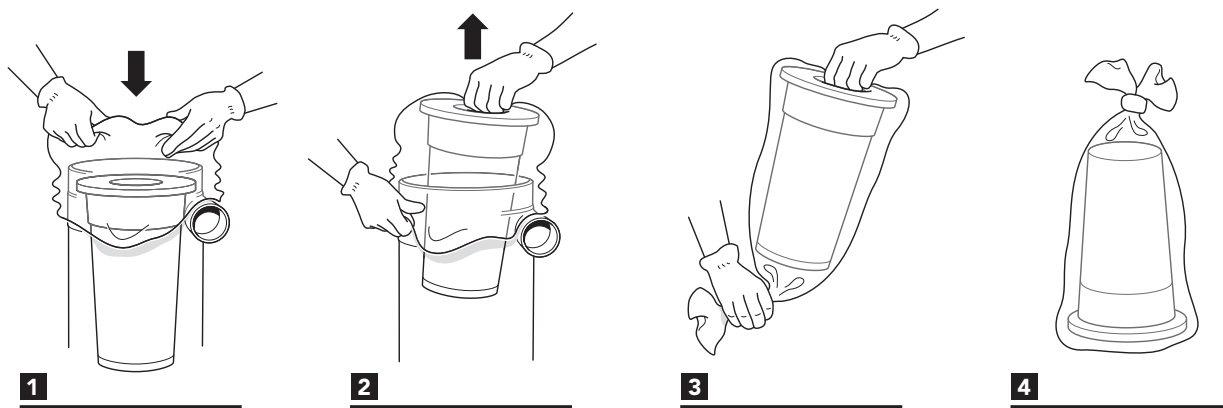

### Motor

For viftemotorer er normal levetid for originalbørste 600–700 timer. Børsten kan byttes. For den andre børstepakken er levetiden cirka 400 timer, og for den tredje børstepakken er levetiden cirka 300 timer. Deretter er kollektoren utslitt, og motoren må byttes.

### Regelmessig sjekk

Kontroller regelmessig at strømledningen ikke har blitt skadet.

## Forbruksvarer og tilbehør

Betegnelse	Artikkelnr.
Plastsekk, standard	42291
Plastsekk (XL)	42285
Finfilter cellulose, med integrert filterbeskyttelse	42029
Finfilter PTFE, med integrert filterbeskyttelse	42028-02
HEPA filter	42027
Kurv for plastsekk	42369
Sugeslange (Ø 38) 5 m	2105 + 2108
Antistatisk sugeslange (Ø 38) 5 m (XL)	2012 + 2114

## Garanti

Garantiperioden er to år og dekker fabrikkfeil. Garantien gjelder forutsatt at maskinen brukes på normal måte, og får nødvendig service. Normal slitasje dekkes ikke. Reparasjoner skal utføres av Dustcontrol eller en person som Dustcontrol har godkjent. Ellers bortfaller garantien.

### Motor

Motoren(e) til produktet dekkes ikke av garantien. Prøvelevetid for en motor kan være mellom 600 - 700 driftstimer. Kontakt Dustcontrol hvis du trenger å bytte motor.

## Feilsøking

Problem	Arsak	Tiltak
Motoren går ikke.	Strøm er ikke tilkoblet.	Koble til strøm.
Motoren stopper umiddelbart etter start.	Feil sikring.	Bytt til riktig sikring.
Motoren går, men maskinen suger ikke.	Sugeslange er ikke tilkoblet.	Koble til slangen.
Motoren går, men maskinen suger svakt.	Hull på sugeslangen.	Bytt slange.
	Tett filter.	Rens eller bytt.
	Sugeslangen er for lang eller trang.	Bytt slange.
	Slangen er delvis tett.	Snu slangen, eller rens den.
	Maskinens topp er dårlig montert.	Juster monteringen.
Motoren stopper under drift.	Det sitter fast støv i syklonen.	Fjern toppen, og rens syklonen.
	Motoren er overopphetet.	Sjekk at maskinen ikke er strupet og vent til maskinen er avkjølt (ca. 30min).
Maskinen blåser ut støv.	Filteret har løsnet eller blitt ødelagt.	Kontroller, og bytt ved behov.
Unormal lyd fra maskinen.		Bestill service.



## EU-erklæring

Vi bekrefter herved at DC 1800 H, Autostart & XL er i samsvar med følgende forskrifter og standarder:

2006/42/EC, 2014/30/EU, 2014/35/EU, EN 60204-1:2018, EN1822-1:2019.

Dustcontrol AB



**Nina Uggowitzer / CEO & Technical Manager**

**2024-10-18**

## Reservedeler

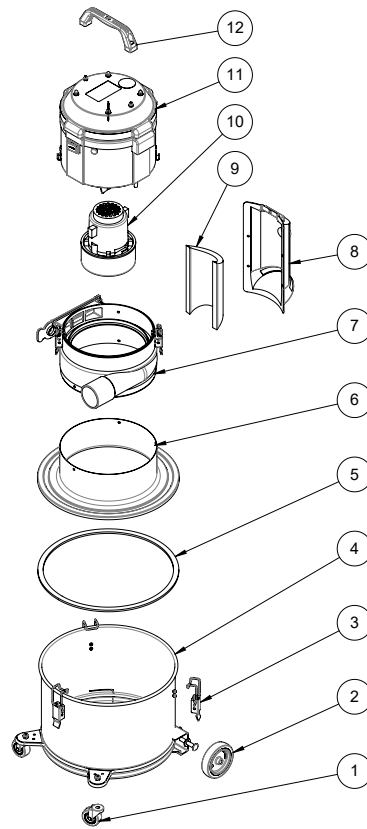

Nummer	Artikkelnr.	Betegnelse
1	42308	Linkhjul D50 H64
2	42307	Hjul D100
3	42365	Eksentrisk lås
4*	42278-40	Container
	40444-1	Beholder XL
5	40514	Pakning 15x8 Selvklebende
6	42276	Syklon/Cap
7	940453-70	Innløpsmodul
8	42275	Eksoskanal
9	42284	Lydabsorberende
10	41800	Motorpakke Eco 1285W
	41801	Motorpakke Auto Eco 1285W
11	41801-70	Motortopp, DC Auto Eco 1285W
12	426700	Håndtak

# Kontakt

## Dustcontrol Worldwide

 **AT**  
Dustcontrol Ges.m.b.H.  
info@dustcontrol.at  
www.dustcontrol.at

 **AU**  
All Preparation Equipment  
www.allprep.com.au

 **BENELUX**  
Dust Solutions BV  
www.dustsolutions.nl

 **BG**  
Metaltech14 Ltd.  
metaltech14@abv.bg  
www.dustcontrolbg.com

 **CA** Dustcontrol  
Canada Inc.  
info@dustcontrol.ca  
www.dustcontrol.ca

 **CH**  
Rosset Technik Maschinen  
Werkzeuge AG  
info@rosset-technik.ch  
www.rosset-technik.ch

 **CL**  
Beckart Tecnologia Ambiental S.A.  
ambitec@ambitec.cl  
www.ambitec.cl

 **CN**  
Suzhou Dustcollect Filtration  
Technology Co. Ltd.  
wang@dustcollect.cn  
www.dustcollect.cn

 **CZ / SK** Ener  
Group CZ, S.R.O. Infolinka:  
+420 602 795 800  
info@energrou.cz  
www.prumysloveodsavani.cz/

 **DE**  
Dustcontrol GmbH  
info@dustcontrol.de  
www.dustcontrol.de

 **DK**  
Construction – Erenfred Pedersen A/S  
info@ep.dk  
www.ep.dk  
  
Industry – Dansk Procesventilation ApS  
info@dansk-procesventilation.dk  
www.dansk-procesventilation.dk

 **EE**  
G-Color Baltic OÜ  
sales@g-color.ee  
www.g-color.ee

 **ES**  
Barin, s.a.  
info@barin.es  
www.barin.es

 **GB**  
Dustcontrol UK Ltd.  
sales@dustcontrol.co.uk  
www.dustcontrol.co.uk

 **GR**  
Mavrogiannakis S.A  
ekttox@enternet.gr  
www.ekttoxefits.com.gr

 **FI**  
Dustcontrol FIN OY  
dc@dustcontrol.fi  
www.dustcontrol.fi

 **FR**  
Construction – SMH Equipements  
info@abequipements.com  
www.smhequipements.com

**Industry – Dustcontrol AB**  
info@dustcontrol.fra  
www.dustcontrol.fra

 **HR**  
Kermek d.o.o.  
kruno.nedeljko@kermek.com  
www.kermek.com

 **HU**  
Vandras Kft  
vandras@t-online.hu  
www.vandras.hu

 **IN**  
Advance Ventilation Pve Ltd.  
sales@advanceventilation.com  
www.advanceventilation.com

 **IT**  
Airum srl  
info@airum.com  
www.airum.com

 **KR**  
ESH Engineering Co.  
eshengco@gmail.com  
www.eshengco.com

 **LT**  
UAB Hidromega  
info@hidromega.lt  
www.hidromega.lt

 **LV**  
SIA Reaktivs  
reaktivs@reaktivs.lv  
www.reaktivs.lv

 **MY, ID**  
Stada EnviroSpace Bhd  
info@stada.com.my  
www.stada.com.my

 **NO**  
Teijo Norge A.S  
firmapost@teijo.no  
www.teijo.no

 **NZ**  
Artizan Diamond Tools  
enquiry@artizandiamond.co.nz  
www.artizandiamond.co.nz

 **PE**  
Efixo  
contacto@efixo.pe  
www.efixo.pe

 **PH**  
Sweden Concrete Machines Inc.  
peringe@packoskick.se  
www.swedenconcretemachines.ph

 **PL**  
Bart Sp. z o.o.  
info@bart-vent.pl  
www.bart-vent.pl

 **PT**  
Metec-Mecano Técnica, Lda.  
geral@metec.pt  
www.metec.pt

 **RO**  
AWS Elektrotehnik  
office@awstehnik.ro  
www.awstehnik.ro

General Contractor Industry SRL  
office@gci-grup.ro  
www.gci-grup.ro

 **RS**  
Enel Alati  
eneldoo@eunet.rs  
www.eneldoo.rs

 **RU**  
Centre Vacuum System  
panov.g@movers-td.com  
www.dustcontrolrus.ru

 **SE**  
Dustcontrol AB  
info@dustcontrol.se  
www.dustcontrol.com

 **SG**  
Stada EnviroSpace Pte Ltd  
Info@stada.com.my  
www.stada.com.my

 **TW**  
Goodland Enterprise Co., Ltd.  
sales@goodland.com.tw  
www.goodland.com.tw

 **TH**  
MCON Intertrade Co., Ltd.  
sales@mconintertrade.com  
www.mconintertrade.com

 **TR** Ventek  
Mühendislik Ltd.  
info@ventek.com.tr  
www.ventek.com.tr

 **AE**  
Global Enterprises Trading Co L.L.C.  
sales@globalentco.com  
www.globalentco.com

**GEM**  
Industrial Equipment Trading Co. Tel:  
+971 4 8840 474  
Email: gemuae@eim.ae

 **UA**  
MBK Obshemashkontrakt, JSC  
zao@omk.dp.ua  
www.omk.dp.ua

 **US**  
Dustcontrol Inc.  
info@dustcontrolusa.com  
www.dustcontrol.us

 **VN**  
Tayhostar JSC  
tayhostar@tayhostar.vn  
www.tayhostar.vn

Please contact the head office  
in Sweden if you do not find a  
distributor in your area.  
info@dustcontrol.se

## Juridisk meddelelse



### BEMÆRK

Oversættelse af den originale brugermanual



### VIGTIGT

Læs brugervejledningen, før du bruger maskinen.



### VIGTIGT

Dustcontrol forbeholder sig retten til at ændre specifikationer uden varsel og er ikke forpligtet til at ændre tidligere leverede produkter. Dustcontrol er ikke ansvarlig for fejl eller udeladelser i denne brugervejledning.



### VIGTIGT

Alle relevante statslige, regionale og lokale sikkerhedsbestemmelser skal følges ved installation og brug af dette produkt. Af sikkerhedsmæssige årsager og for at sikre overholdelse af dokumenterede systemdata er det kun fabrikanten, der skal udføre komponentreparationer. Manglende overholdelse af disse oplysninger kan resultere i personskade eller beskadigelse af udstyr.



### VIGTIGT

Alle rettigheder forbeholdes. Ingen del af denne publikation må reproduceres, distribueres eller transmitteres i nogen form eller på nogen måde, herunder fotokopiering, optagelse eller andre elektroniske eller mekaniske midler, uden forudgående skriftlig tilladelse fra udgiveren. For tilladelsesforespørgsler, kontakt Dustcontrol.



### BEMÆRK

Produktet er fremstillet af:

Dustcontrol AB  
Box 3088, Kumla Gårdsväg 14  
SE-145 03 Norsborg  
Tel: +46 8 531 940 00  
support@dustcontrol.se  
www.dustcontrol.com

## Sikkerhedsbestemmelser

### Intro

Læs følgende sikkerhedsinstruktioner, før du starter denne maskine. Gem brugervejledningen. Hvis sikkerhedsforskrifterne ikke overholdes, gælder garantien ikke. Der kan også opstå person- og produktskader. Dustcontrol er ikke ansvarlig for skader på udstyret forårsaget af forkert installation eller forkert håndtering af udstyret.

### Advarsel

Denne maskine er kun beregnet til professionel brug.

Børn skal være under opsyn for at sikre, at de ikke leger med maskinen.

Brug kun originalt tilbehør og forbrugsstoffer, der er inkluderet i Dustcontrols sortiment.



#### ADVARSEL

Brug maskinen til det tilsigtede formål. Følg forskrifterne vedrørende det materiale, der opsuges.



#### ADVARSEL

Denne maskine er kun beregnet til opsugning af tørt materiale.



#### ADVARSEL

Ved brug af elektriske apparater skal de grundlæggende sikkerhedsforskrifter overholdes for at mindske risikoen for brand, elektrisk stød eller personskade.



#### ADVARSEL

Der må ikke suges varme, glødende partikler eller andre antændelseskilder ind i maskinen. Maskinen må ikke anvendes til eksplosive, ustabile eller selvantændelige partikler.



#### ADVARSEL

Ved anvendelse af defekte brugsartikler eller uoriginalt tilbehør (især filtre, slanger og plastsække) kan maskinen lække sundhedsskadeligt støv med personskade til følge.

### Miljøbeskyttelse

Genbrug emballage og inkluderede komponenter i henhold til lokale regler. For mere information kontakt din nærmeste genbrugsstation eller Dustcontrol for maskinskrotning.

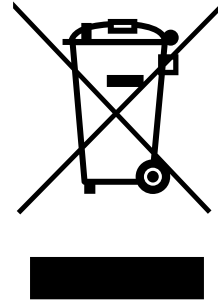
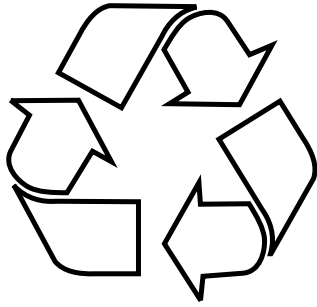

### WEEE (Waste of Electric and Electronic Equipment)

Gælder kun EU-lande: Elektrisk værktøj må ikke bortskaffes som husholdningsaffald. Ifølge direktiv 2002/96/EF om affald af elektrisk og elektronisk udstyr og den nationale lovgivning til gennemførelse heraf skal udtjent elektrisk udstyr sorteres separat og afleveres til miljøvenlig genbrug.

### Arbejds miljø

Maskinen må ikke udsættes for fugt. Må ikke anvendes i fugtige og våde områder eller i nærheden af letantændelige væsker eller gasser.



#### PAS PÅ

Denne maskine må kun anvendes og opbevares i et tørt miljø.



#### PAS PÅ

Maskinen må ikke skylles med vand.

### Overbelaste



#### PAS PÅ

Lad ikke maskinen arbejde helt droslet, da det medfører fare for overophedning.

### Kropsskader



#### ADVARSEL

Forsøg ikke at ændre de elektriske tilslutninger selv. En fejl kan medføre livsfare!



#### ADVARSEL

Lad aldrig sugepunktet komme i kontakt med nogen legemsdel. Det kraftige undertryk kan beskadige hudens blodkar.



### ADVARSEL

Der skal anvendes beskyttelseshandsker ved montering, håndtering og transport af produktet.

## Elektrisk kabel



### ADVARSEL

Maskinen må ikke flyttes ved at trække i strømledningen. Udsæt ikke strømledningen for varme eller skarpe genstande. Kontrollér strømledningen regelmæssigt.

Når der anvendes et forlængerkabel, skal det sikres, at forbindelsen er vandtæt.

Maskinen må ikke anvendes, hvis strømledningerne eller kontakterne er beskadiget.

Hvis strømledningen er beskadiget, skal den udskiftes af Dustcontrol eller af et serviceværksted, som Dustcontrol har autoriseret.

## Vigtig handling

Inden rengøring eller vedligeholdelse af maskinen skal du slukke for hovedafbryderen og tage maskinens stik ud af kontakten.

Denne maskine må kun bruges, hvis alle filtre er ubeskadigede og korrekt monteret.

## Omsorg

Maskinen skal holdes ren og fri for støvaflejringer. Sørg for, at sugeslangen er intakt, og at alle tætninger er intakte og fejlfri. Hold bærehåndtagene tørre og fri for olie og fedt.

## Kontrollere

Kontrollér regelmæssigt enheden for skader og slitage. Opstår der skader, skal de udbedres af Dustcontrols servicetekniker eller af et serviceværksted, som er autoriseret af Dustcontrol.

## Funktionsbeskrivelse

Støvsamleren arbejder med undertryk (suge) som driver luften gennem sugehætte/mundstykke, slangesystem og for- og støvudskiller. Grovseparatoring foregår i enhedens cyklon, som er en meget effektiv adskillelse af stadigt grovere støv. Det fine støv udskilles i enhedens filter. Filterrensning med luftpuls giver filtrene ekstra lang levetid. Maskinen er udstyret med HEPA-filtre.

Støvudskilleren er driftssikker og robust. Den er særligt velegnet til opugning og fjernelse af tørt, sundhedsfarligt, ikke-brændbart støv i klasse H samt støv med ELV (eksponeringsgrænseværdi) og støv fra kræftfremkaldende stoffer i henhold til GefStoffV (tysk forordning om farlige stoffer).

<b>H</b>	<p><b>WARNING:</b> This machine contains dust hazardous to health. Emptying and maintenance operations, including removal of the dust collection means, must only be carried out by authorised personnel wearing suitable personal protection. Do not operate without the full filtration system fitted.</p>	<p><b>ACHTUNG:</b> Dieses Gerät enthält gesundheitsschädlichen Staub. Leerungs- und Wartungsvorgänge, einschließlich der Beseitigung der Staubsammelbehälter, dürfen nur von Fachleuten durchgeführt werden, die entsprechende Schutzausrüstung tragen. Nicht ohne das vollständige Filtrationssystem betreiben.</p>	<p><b>VARNING:</b> Denna utrustning innehåller hälsofarligt damm. Tömning och service, inklusive filterbyte, får endast utföras av en fackman med lämplig personlig skyddsutrustning. Får ej användas utan komplett filtersystem.</p>	<b>H</b>
----------	--	--	---	----------



## Teknisk data

Teknisk data	DC 1800H	DC 1800H XL
H x B x D [mm]	780 x 405 x 390	1225 x 402 x 382
Vægt [kg]	14	19
Indløb [mm]	Ø50	Ø50
Slangelængde Ø38 [m]	5	5
Opsamlingsbeholder [l]	20	55
Flow maks. [m <sup>3</sup> /h]	205	205
Undertryk maks. [kPa]	24	24
Effektudtag [W]	1285 (230 V)	1285 (230 V)
Auto: Effekt tilsluttet værktøj*/min. 200 W	115/230 V/ 10A: 1340/1285 W	115/230 V/10 A: 1340/1285 W
	230 V/16 A: 2200 W	230 V/16 A: 2200 W
Fin filtercellulose, areal [m <sup>2</sup> ]	1,5	1,5
Udskilningsgrad finfilter, EN 60335-2-69, klasse M [%]	99,9	99,9
Filteroverflade HEPA-filter [m <sup>2</sup> ]	0,85	0,85
Maskinens udskilningsgrad, EN 60335-2-69, bilag A-A, klasse H [%]	99,995	99,995
Filterklassificering, EN 1822-1	HEPA H13	HEPA H13
Lydniveau [dB(A)]	< 66	< 68
IP	44	44

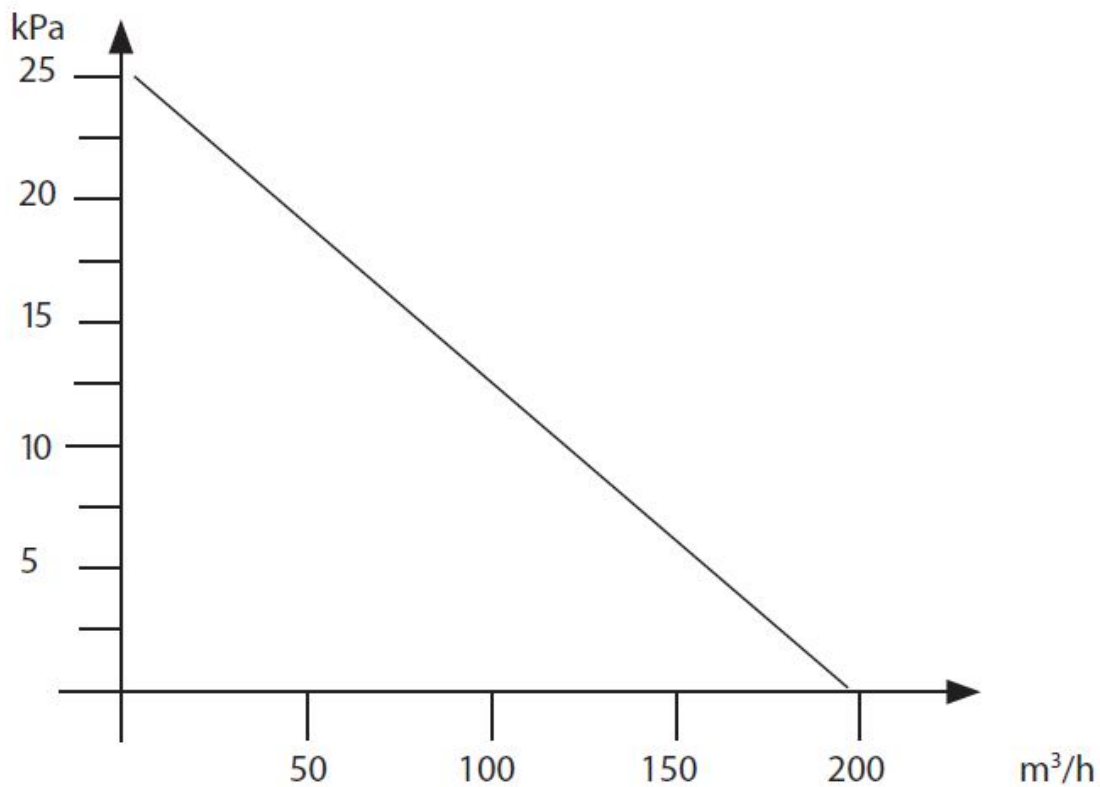

Trykgenerering og luftstrøm

## Operation

### Tilslutning

Tilslut maskinen til et eludtag med spænding i henhold til specifikationerne på maskinens mærkeplade.

### Autostart

Tilslut det elektriske værktøj til udtaget på maskinen. Indstil omkobleren i positionen AUTO. Maskinen starter derefter automatisk, når værktøjet startes. Maskinen slukkes nogle sekunder efter, at det tilsluttede værktøj slukkes. Hvis du ønsker manuel start af sugningen, skal omkobleren indstilles i positionen MAN.

### Filterrensning

Maskinen har en filterindikatorlampe, som lyser, når filtret skal renses eller udskiftes.

Sådan renses filtret:

Ved rensning af filtret skal maskinen køre, og slangen skal fjernes fra indsugningsrøret.

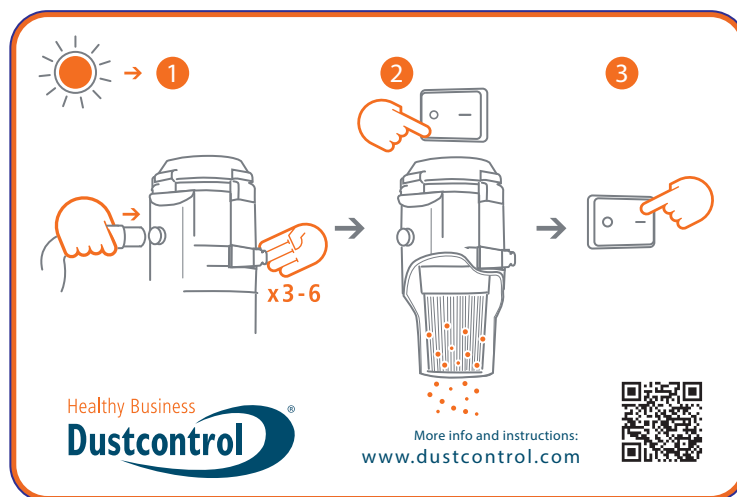

1. Pres tilslutningsmuffen mod den sorte prop på aftrækskanalen eller mod gulvet, så der skabes maksimalt undertryk i cyklonen. Åbn derefter klappen på siden 3-6 gange. Luften strømmer ind i maskinen og renses filteret med pulsvirkningen.
2. Sluk for maskinen og lad materialet falde ned. Tilslut sugeslangen igen.
3. Start maskinen.

### Tømning

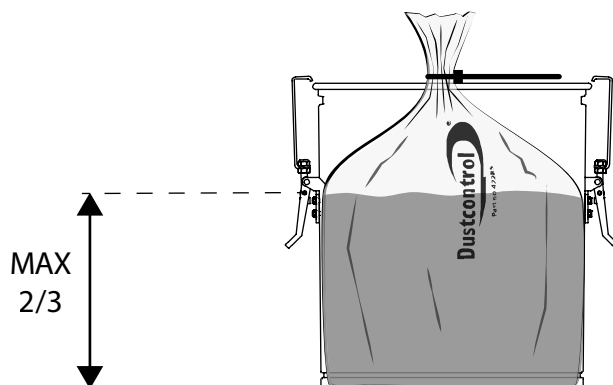

Beholderen under cyklonen bør tømmes, når den er fyldt til maksimalt 2/3.

## Service & vedligeholdelse

### Rengøring

Ved rengøring og vedligeholdelse af maskinen skal du slukke for maskinen og trække stikket ud.

### Udskiftning af filter

Finfilteret skal skiftes mindst en gang om året. HEPA-filteret skal udskiftes efter 300 driftstimer. Der må kun bruges originale filtre.



#### ADVARSEL

Udskiftning af filteret må kun udføres af uddannet personale. Brug beskyttelsesmaske og egnet udstyr.

1. Løsn og løft dækslet af for at få fri adgang til filteret. Læg derefter en plastikpose over cyklonen.
2. Løft filteret lige op i plastikposen. Kontroller derefter, at pakningen er komplet. I tilfælde af skader skal pakningen udskiftes for at sikre tæthed.
3. Bind sækken rundt om filteret.
4. Bortskaf filteret og plastikposen korrekt.

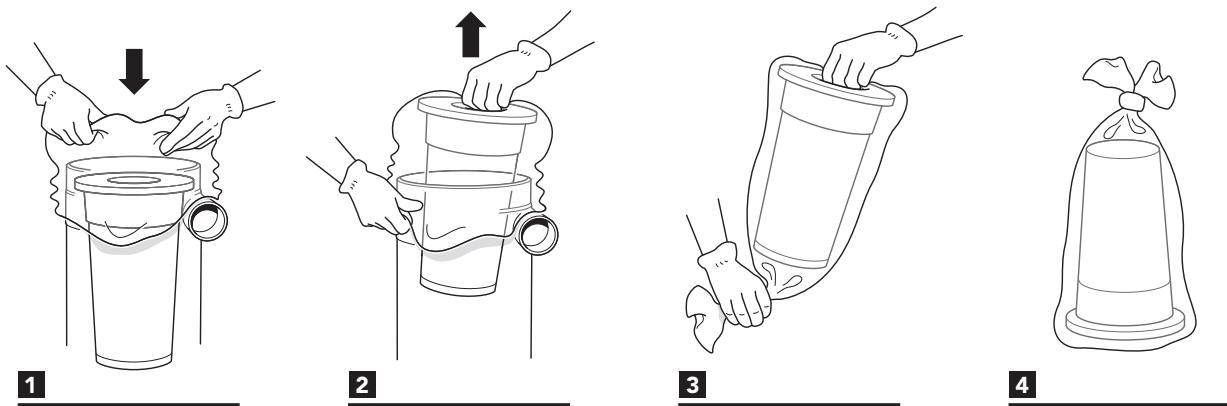

### Motor

For ventilatormotorer er den typiske levetid for originale børster 600-700 timer. Børsten kan udskiftes. For den anden børstepakke er levetiden ca. 400 timer og for den tredje børstepakke ca. 300 timer. Herefter er kollektoren slidt op, og motoren skal udskiftes.

### Regelmæssig kontrol

Kontrollér regelmæssigt, at strømledningen ikke er beskadiget.

## Forbrugsvarer og tilbehør

Betegnelse	Art. nr.
Plastsæk, standard	42291
Plastsæk (XL)	42285
Finfilter, cellulose med integreret filterbeskyttelse	42029
Fint filter PTFE, med integreret filterbeskyttelse	42028-02
HEPA filter	42027
Kurv til plastsæk	42369
Sugeslange (Ø 38) 5 m	2105 + 2108
Antistatisk sugeslange (Ø 38) 5 m (XL)	2012 + 2114

## Garanti

Garantiperioden er to år og dækker fabrikationsfejl. Garantien gælder, forudsat at maskinen anvendes på normal vis og får den nødvendige service. Normal slitage erstattes ikke. Reparationer skal udføres af Dustcontrol eller af personer, som er godkendt af Dustcontrol. Ellers bortfalder garantien.

### Motor

Produktets motor(er) er ikke dækket af garantien. Prøvelevetid for en motor kan være mellem 600 - 700 driftstimer. Kontakt Dustcontrol, hvis du skal skifte motor.

## Fejlfinding

Problem	Årsag	Afhjælpning
Motoren kører ikke.	Der er ikke tilsluttet strøm.	Tilslut strøm.
Motoren stopper lige efter start.	Forkert sikring.	Skift til korrekt sikring.
Motoren kører, men maskinen suger ikke.	Sugeslangen er ikke tilsluttet. Blokering i slangen.	Tilslut slangen. Vend slangen, eller rens den.
Motoren kører, men maskinen suger dårligt.	Hul på sugeslangen.	Skift slange.
	Tilstoppet filter.	Rens eller udskift den.
	Sugeslangen er for lang eller smal.	Skift slange.
	Slangen er delvist tilstoppet.	Vend slangen, eller rens den.
	Maskinens overdelt er dårligt monteret.	Juster monteringen.
	Der sidder støv fast i cyklonen.	Tag overdelen af, og rengør cyklonen.
Motoren stopper under drift.	Motoren er overophedet.	Tjek at maskinen ikke er drøstet og vent til maskinen er kølet af (ca. 30min).
Maskinen blæser støv ud.	Filtret har løsnet sig eller er gået i stykker.	Kontrollér det, og udskift det efter behov.
Unormal lyd fra maskinen.		Bestil service.

## EF-overensstemmelseserklæring

Vi bekræfter hermed, at DC 1800 H, Autostart & XL er i overensstemmelse med følgende regler og standarder:

2006/42/EC, 2014/30/EU, 2014/35/EU, EN 60204-1:2018, EN1822-1:2019.

Dustcontrol AB



**Nina Uggowitzer / CEO & Technical Manager**

2024-10-18

# Reserve dele

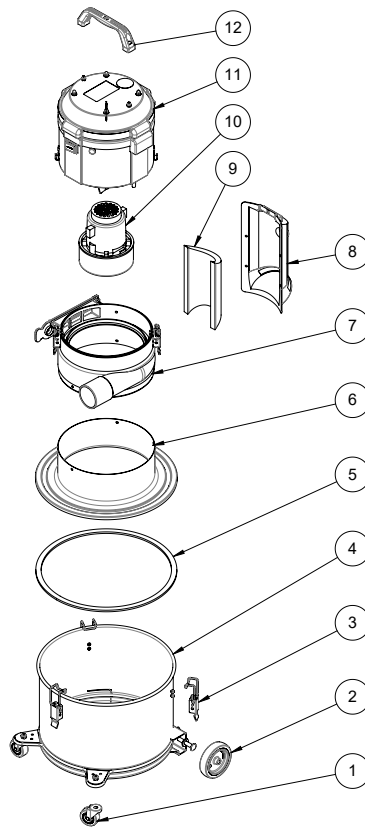

Nummer	Art.-nr.	Betegnelse
1	42308	Linkhjul D50 H64
2	42307	Hjul D100
3	42365	Excenterlås
4*	42278-40	Beholder
	40444-1	Beholder XL
5	40514	Pakning 15x8 Selvklæbende
6	42276	Cyklon/Cap
7	940453-70	Indløbsmodul
8	42275	Aftrækskanal
9	42284	Lydabsorberende
10	41800	Motorpakke Eco 1285W
	41801	Motorpakke Auto Eco 1285W
11	41801-70	Motortop, DC Auto Eco 1285W
12	426700	Håndtere



# Kontakte

## Dustcontrol Worldwide



**AT**  
Dustcontrol Ges.m.b.H.  
info@dustcontrol.at  
www.dustcontrol.at



**AU**  
All Preparation Equipment  
www.allprep.com.au



**BENELUX**  
Dust Solutions BV  
www.dustsolutions.nl



**BG**  
Metaltech14 Ltd.  
metaltech14@abv.bg  
www.dustcontrolbg.com



**CA** Dustcontrol  
Canada Inc.  
info@dustcontrol.ca  
www.dustcontrol.ca



**CH**  
Rosset Technik Maschinen  
Werkzeuge AG  
info@rosset-technik.ch  
www.rosset-technik.ch



**CL**  
Beckart Tecnologia Ambiental S.A.  
ambitec@ambitec.cl  
www.ambitec.cl



**CN**  
Suzhou Dustcollect Filtration  
Technology Co. Ltd.  
wang@dustcollect.cn  
www.dustcollect.cn



**CZ / SK** Ener  
Group CZ, S.R.O. Infolinka:  
+420 602 795 800  
info@energrou.cz  
www.prumysloveodsavani.cz/



**DE**  
Dustcontrol GmbH  
info@dustcontrol.de  
www.dustcontrol.de



**DK**  
Construction – Erenfred Pedersen A/S  
info@ep.dk  
www.ep.dk  
  
Industry – Dansk Procesventilation ApS  
info@dansk-procesventilation.dk  
www.dansk-procesventilation.dk



**EE**  
G-Color Baltic OÜ  
sales@g-color.ee  
www.g-color.ee



**ES**  
Barin, s.a.  
info@barin.es  
www.barin.es



**GB**  
Dustcontrol UK Ltd.  
sales@dustcontrol.co.uk  
www.dustcontrol.co.uk



**GR**  
Mavrogiannakis S.A  
ekttox@enternet.gr  
www.ekttoxefits.com.gr



**FI**  
Dustcontrol FIN OY  
dc@dustcontrol.fi  
www.dustcontrol.fi



**FR**  
Construction – SMH Equipements  
info@abequipements.com  
www.smhequipements.com



Industry – Dustcontrol AB  
info@dustcontrol.fra  
www.dustcontrol.fra



**HR**  
Kermek d.o.o.  
kruno.nedeljko@kermek.com  
www.kermek.com



**HU**  
Vandras Kft  
vandras@t-online.hu  
www.vandras.hu



**IN**  
Advance Ventilation Pve Ltd.  
sales@advanceventilation.com  
www.advanceventilation.com



**IT**  
Airum srl  
info@airum.com  
www.airum.com



**KR**  
ESH Engineering Co.  
eshengco@gmail.com  
www.eshengco.com



**LT**  
UAB Hidromega  
info@hidromega.lt  
www.hidromega.lt



**LV**  
SIA Reaktivs  
reaktivs@reaktivs.lv  
www.reaktivs.lv



**MY, ID**  
Städa EnviroSpace Bhd  
info@stada.com.my  
www.stada.com.my



**NO**  
Teijo Norge A.S  
firmapost@teijo.no  
www.teijo.no



**NZ**  
Artizan Diamond Tools  
enquiry@artizandiamond.co.nz  
www.artizandiamond.co.nz



**PE**  
Efixo  
contacto@efixo.pe  
www.efixo.pe



**PH**  
Sweden Concrete Machines Inc.  
peringe@packoskick.se  
www.swedenconcretemachines.ph



**PL**  
Bart Sp. z o.o.  
info@bart-vent.pl  
www.bart-vent.pl



**PT**  
Metec-Mecano Técnica, Lda.  
geral@metec.pt  
www.metec.pt



**RO**  
AWS Elektrotehnik  
office@awstehnik.ro  
www.awstehnik.ro

General Contractor Industry SRL  
office@gci-grup.ro  
www.gci-grup.ro



**RS**  
Enel Alati  
eneldoo@eunet.rs  
www.eneldoo.rs



**RU**  
Centre Vacuum System  
panov.g@movers-td.com  
www.dustcontrolrus.ru



**SE**  
Dustcontrol AB  
info@dustcontrol.se  
www.dustcontrol.com



**SG**  
Städa EnviroSpace Pte Ltd  
Info@stada.com.my  
www.stada.com.my



**TW**  
Goodland Enterprise Co., Ltd.  
sales@goodland.com.tw  
www.goodland.com.tw



**TH**  
MCON Intertrade Co., Ltd.  
sales@mconintertrade.com  
www.mconintertrade.com



**TR** Ventek  
Mühendislik Ltd.  
info@ventek.com.tr  
www.ventek.com.tr



**AE**  
Global Enterprises Trading Co L.L.C.  
sales@globalentco.com  
www.globalentco.com



**GEM**  
Industrial Equipment Trading Co. Tel:  
+971 4 8840 474  
Email: gemuae@eim.ae



**UA**  
MBK Obshemashkontrakt, JSC  
zao@omk.dp.ua  
www.omk.dp.ua



**US**  
Dustcontrol Inc.  
info@dustcontrolusa.com  
www.dustcontrol.us



**VN**  
Tayhostar JSC  
tayhostar@tayhostar.vn  
www.tayhostar.vn

Please contact the head office  
in Sweden if you do not find a  
distributor in your area.  
info@dustcontrol.se

## Juridische mededeling



### LET OP

Vertaling van de originele gebruikershandleiding



### BELANGRIJK

Lees de gebruikershandleiding voordat u de machine gebruikt.



### BELANGRIJK

Dustcontrol behoudt zich het recht voor om specificaties zonder voorafgaande kennisgeving te wijzigen en is niet verplicht eerder geleverde producten te wijzigen. Dustcontrol is niet verantwoordelijk voor fouten of weglatingen in deze gebruikershandleiding.



### BELANGRIJK

Bij de installatie en het gebruik van dit product moeten alle relevante staats-, regionale en lokale veiligheidsvoorschriften worden nageleefd. Om veiligheidsredenen en om te garanderen dat de gedocumenteerde systeemgegevens worden nageleefd, mag alleen de fabrikant reparaties aan onderdelen uitvoeren. Het niet opvolgen van deze informatie kan leiden tot persoonlijk letsel of schade aan apparatuur.



### BELANGRIJK

Alle rechten voorbehouden. Niets uit deze publicatie mag worden gereproduceerd, gedistribueerd of verzonden in welke vorm of op welke manier dan ook, inclusief fotokopiëren, opnemen of andere elektronische of mechanische middelen, zonder voorafgaande schriftelijke toestemming van de uitgever. Neem voor vragen over vergunningen contact op met Dustcontrol.



### LET OP

Het product is vervaardigd door:

Dustcontrol AB  
Box 3088, Kumla Gårdsväg 14  
SE-145 03 Norsborg  
Tel: +46 8 531 940 00  
support@dustcontrol.se  
www.dustcontrol.com

## Veiligheidsvoorschriften

### Intro

Lees de volgende veiligheidsinstructies voordat u deze machine start. Bewaar de gebruikershandleiding. Indien de veiligheidsvoorschriften niet worden nageleefd, is de garantie niet van toepassing. Ook persoonlijke en productschade kan voorkomen. Dustcontrol is niet verantwoordelijk voor schade aan de apparatuur veroorzaakt door onjuiste installatie of onjuiste omgang met de apparatuur.

### Waarschuwing

Deze machine is uitsluitend bedoeld voor professioneel gebruik.

Kinderen moeten onder toezicht staan om ervoor te zorgen dat ze niet met de machine spelen.

Gebruik alleen originele accessoires en verbruiksartikelen die in het assortiment van Dustcontrol zijn opgenomen.



#### WAARSCHUWING

Gebruik de machine waarvoor deze bedoelde is. Volg de voorschriften voor het materiaal dat opgezogen wordt.



#### WAARSCHUWING

Deze machine is uitsluitend bedoeld voor het opzuigen van droog materiaal.



#### WAARSCHUWING

Bij gebruik van elektrische apparaten moeten elementaire veiligheidsmaatregelen in acht worden genomen om het risico van brand, elektrische schokken of lichamelijk letsel te verkleinen.



#### WAARSCHUWING

Er mogen geen hete, gloeiende deeltjes of andere ontstekingsbronnen in de machine worden gezogen. De machine mag niet worden gebruikt voor explosieve, instabiele of zelfontbrandende deeltjes.



#### WAARSCHUWING

Indien verkeerde of nagemaakte producten gebruikt worden (met name filter, slangen en plastic zakken) kan er stof uit de machine lekken dat gevaarlijk voor de gezondheid kan zijn, met persoonlijk letsel tot gevolg.

### Milieubescherming

Recycle de verpakking en de meegeleverde componenten volgens de lokale regelgeving. Neem voor meer informatie contact op met het dichtstbijzijnde recyclingcentrum of met Dustcontrol voor het slopen van machines.

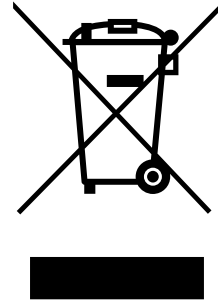
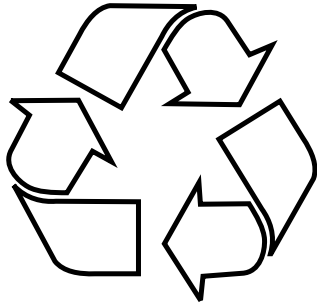

### **WEEE (Waste of Electric and Electronic Equipment), ofwel AEEA: Afval van elektrische en elektronische apparatuur**

Geldt uitsluitende voor EU-landen: Elektrische apparaten mogen niet als huishoudelijk afval worden verwijderd. Volgens Richtlijn 2002/96/EG betreffende oudere elektrische en elektronische apparatuur en de toepassing ervan volgens nationale regelgeving, moeten afgedankte elektrische apparaten apart worden gesorteerd en voor milieuvriendelijke recycling worden aangeboden.

### **Werkomgeving**

Stel de machine niet bloot aan vocht. Niet gebruiken in vochtige en natte ruimten of in de nabijheid van ontvlambare vloeistoffen of gassen.



#### **LET OP**

Deze machine mag alleen gebruikt en opgeslagen worden in een droge omgeving.



#### **LET OP**

De machine mag niet met water worden afgespoeld.

### **Overbelasting**



#### **LET OP**

Laat de machine nooit draaien als deze verstopt is aangezien dit een kans op oververhitting oplevert.

### **Lichamelijke verwondingen**



#### **WAARSCHUWING**

Probeer nooit zelf elektrische verbindingen te wijzigen. Een fout kan levensgevaar opleveren!



### **WAARSCHUWING**

Zorg dat het zuigmondstuk nooit in contact komt met een lichaamsdeel. De sterke onderdruk kan bloedvaten in de huid beschadigen.



### **WAARSCHUWING**

Bij het monteren, hanteren en vervoeren van het product moeten beschermende handschoenen worden gebruikt.

## **Elektrische kabel**



### **WAARSCHUWING**

Trek de machine nooit aan het netsnoer voort. Zorg dat het netsnoer niet beschadigd raakt door warmte en scherpe voorwerpen. Controleer het netsnoer regelmatig.

Bij het verlengen van het netsnoer, moet het verlengsnoer waterbestendig zijn.

De machine mag niet worden gebruikt als het netsnoer of de stekker beschadigd zijn.

Als het netsnoer beschadigd is, moet het worden vervangen door Dustcontrol of door een door Dustcontrol geautoriseerde werkplaats.

## **Belangrijke actie**

Voordat u de machine gaat schoonmaken of er onderhoud aan gaat plegen moet u de hoofdschakelaar uitzetten en de machine van het net loskoppelen.

Deze machine mag alleen worden gebruikt als alle filters onbeschadigd zijn en correct zijn gemonteerd.

## **Zorg**

Houd de machine schoon en vrij van stofafzettingen. Let er op dat de zuigslang heel is en dat alle aansluitingen intact en foutvrij zijn. De draaghandgrepen moeten droog gehouden worden en vrij van olie en vet.

## **Controle**

Controleer het apparaat regelmatig op schade of slijtage. Bij schade moet dit verholpen worden door een service-monteur van Dustcontrol of een door Dustcontrol geautoriseerde werkplaats.

## Beschrijving van de werking

De stofafscheider werkt met onderdruk (aanzuiging) die de lucht door de afzuigkap/nozzle, slangstelsysteem en voor- en stofafscheider drijft. Grote afscheiding vindt plaats in de cycloon van de unit, een zeer efficiënte afscheiding van steeds grover stof. Het fijne stof wordt afgescheiden in het filter van het toestel. Filterreiniging met luchtpuls geeft de filters een extra lange levensduur. De machine is uitgerust met HEPA-filters.

De stofafscheider is bedrijfszeker en robuust. Hij is speciaal geschikt voor het opzuigen en verwijderen van droog, schadelijke, niet-brandbaar stof van klasse H, stof met ELV en stof van kankerverwekkende materialen volgens GefStoffV (German Hazardous Substances Ordinance).

<b>H</b>	<p><b>WARNING:</b> This machine contains dust hazardous to health. Emptying and maintenance operations, including removal of the dust collection means, must only be carried out by authorised personnel wearing suitable personal protection. Do not operate without the full filtration system fitted.</p>	<p><b>ACHTUNG:</b> Dieses Gerät enthält gesundheitsschädlichen Staub. Leerungs- und Wartungsvorgänge, einschließlich der Beseitigung der Staubsammelbehälter, dürfen nur von Fachleuten durchgeführt werden, die entsprechende Schutzausrüstung tragen. Nicht ohne das vollständige Filtrationssystem betreiben.</p>	<p><b>VARNING:</b> Denna utrustning innehåller hälsofarligt damm. Tömning och service, inklusive filterbyte, får endast utföras av en fackman med lämplig personlig skyddsutrustning. Får ej användas utan komplett filtersystem.</p>	<b>H</b>
----------	--	--	---	----------

## Technische gegevens

Technische data	DC 1800H	DC 1800H XL
HxBxD [mm]	780 x 405 x 390	1225 x 402 x 382
Gewicht [kg]	14	19
Ingang [mm]	Ø50	Ø50
Slanglengte Ø38 [m]	5	5
Opvangcontainer [l]	20	55
Flow max [m <sup>3</sup> /u]	205	205
Onderdruk max [kPa]	24	24
Vermogen [W]	1285 (230 V)	1285 (230 V)
Auto: Vermogen aangesloten gereedschappen*/min 200W	115/230 V/ 10A: 1340/1285 W 230 V/16 A: 2200 W	115/230 V/10 A: 1340/1285 W 230 V/16 A: 2200 W
Fijne filtercellulose, oppervlakte [m <sup>2</sup> ]	1,5	1,5
Filtervermogen fijnfilter, EN 60335-2-69, Klasse M [%]	99,9	99,9
Filteroppervlak HEPA-filter [m <sup>2</sup> ]	0,85	0,85
Filtervermogen machine, EN 60335-2-69, Aanhangsel A-A, klasse H [%]	99,995	99,995
Filterclassificatie, EN 1822-1	HEPA H13	HEPA H13
Geluidsniveau [dB(A)]	< 66	< 68
IP	44	44

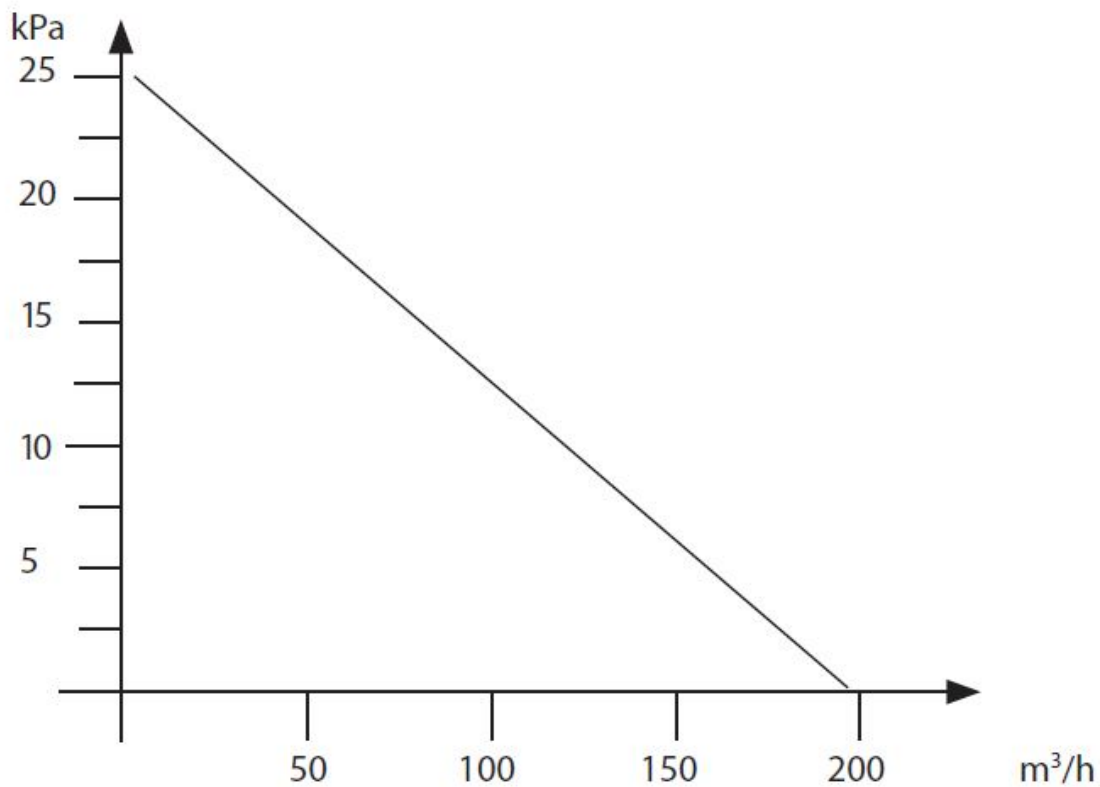

Drukopwekking en luchtstroom

## Operatie

### Aansluiting

Sluit de machine aan op een stopcontact met spanning volgens de specificaties op het typeplaatje van de machine.

### Auto-start

Sluit een elektrisch gereedschap aan op het stopcontact op de machine. Zet de schakelaar op de stand AUTO. De machine start dan automatisch wanneer het gereedschap wordt gestart. Een paar seconden nadat het aangesloten gereedschap is uitgezet, wordt de machine uitgeschakeld. Zet de schakelaar in de stand MAN om het opzuigen handmatig te starten.

### Reinigen van het filter

De machine heeft een filterindicatielampje dat gaat branden wanneer het filter gereinigd of vervangen moet worden.

Zo maakt u het filter schoon:

Tijdens het reinigen van het filter moet de machine in bedrijf zijn en moet de slang losgemaakt zijn van de afzuigbuis.

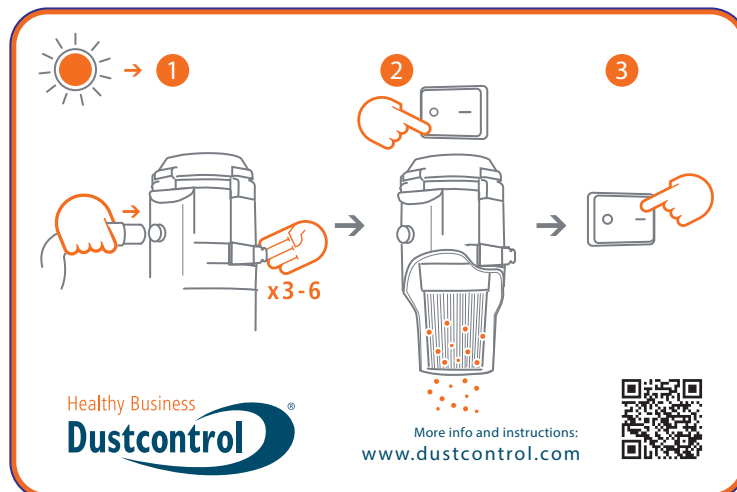

1. Druk de aansluitmof tegen de zwarte stop op het uitlaatkanaal of tegen de vloer, zodat er maximale onderdruk ontstaat in de cycloon. Open vervolgens de flap aan de zijkant 3-6 keer. De lucht stroomt de machine in en reinigt het filter met de pulsactie.
2. Zet de machine uit en laat het materiaal naar beneden vallen. Sluit de zuigbuis weer aan.
3. Start de machine.

### Legen

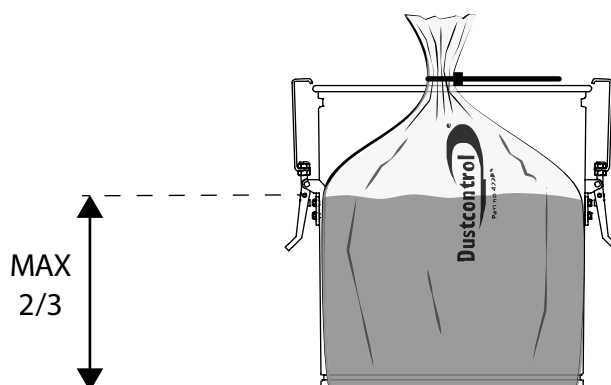



De container onder de cycloon dient geleegd te worden wanneer deze voor maximaal 2/3 gevuld is.

## Service & onderhoud

### Schoonmaken

Bij het reinigen en onderhouden van de machine moet de machine uitgeschakeld zijn en de stekker uit het stopcontact getrokken worden.

### Filtervervanging

Het fijnfilter moet minimaal één keer per jaar worden vervangen. Het HEPA-filter moet na 300 bedrijfsuren worden vervangen. Er mogen uitsluitend originele filters worden gebruikt.



#### WAARSCHUWING

Een filter vervangen mag alleen worden uitgevoerd door geïnstrueerd personeel. Gebruik een beschermend masker en geschikte apparatuur.

1. Maak het deksel los en til het op om vrije toegang tot het filter te krijgen. Plaats vervolgens een plastic zak over de cycloon.
2. Til het filter recht omhoog in de plastic zak. Controleer vervolgens of de verpakking compleet is. In geval van schade moet de pakking worden vervangen om de dichtheid te garanderen.
3. Bind de zak om het filter.
4. Gooi het filter en de plastic zak op de juiste manier weg.

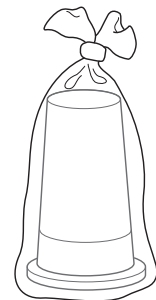
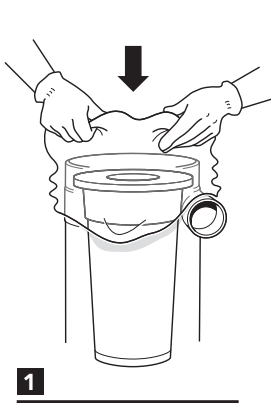

### Motor

Voor ventilatormotoren is de typische levensduur van de originele borstels 600-700 uur. De borstels kunnen vervangen worden. De levensduur van het tweede borstelpakket is ongeveer 400 uur en het derde borstelpakket gaat ongeveer 300 uur mee. Hierna is de rotor versleten en moet de motor vervangen worden.

### Regelmatige controle

Controleer regelmatig of het netsnoer niet beschadigd is.

## Verbruiksartikelen en accessoires

Naam	Art.nr.
Plastic zak, standaard	42291
Plastic zak (XL)	42285
Fijnfilter cellulose, met geïntegreerde filterbescherming	42029
Fijnfilter PTFE, met geïntegreerde filterbescherming	42028-02
HEPA-filter	42027
Mand voor plastic zak	42369
Zuigslang (Ø 38) 5 m	2105 + 2108
Antistatische zuigslang (Ø 38) 5 m (XL)	2012 + 2114

## Garantie

De garantieperiode is twee jaar en heeft betrekking op fabricagefouten. De garantie geldt op voorwaarde dat de machine wordt gebruikt op normale wijze en de vereiste service ontvangt. Normale slijtage wordt niet vergoed. Reparaties moeten worden uitgevoerd door Dustcontrol of door een persoon die door Dustcontrol is goedgekeurd. Anders kan de garantie komen te vervallen.

### **Motor**

De motor(en) van het product vallen niet onder de garantie. De levensduur van een monster voor een motor kan tussen 600 - 700 bedrijfsuren zijn. Neem contact op met Dustcontrol als u de motor moet vervangen.

## Probleemoplossing

Probleem	Oorzaak	Maatregel
De motor werkt niet.	Elektriciteit niet aangesloten.	Sluit de elektriciteit aan.
De motor stopt direct na het starten.	Defecte zekering.	Vervang door een juiste zekering.
De motor loopt, maar de machine zuigt niet.	De zuigslang is niet aangesloten. Slang is verstopt.	Sluit de slang aan. Draai de slang of maak schoon.
De motor loopt, maar de machine zuigt slecht.	Gat in de zuigslang.	Vervang de slang.
	Verstopt filter.	Schoonmaken of vervangen.
	Zuigslang te lang of te smal.	Vervang de slang.
	Slang gedeeltelijk verstopt.	Draai de slang of maak schoon.
	De bovenkant van de machine niet goed geplaatst.	Plaats op de juiste manier.
	Er is stof vast komen te zitten in de cycloon.	Verwijder de bovenkant en maak de cycloon schoon.
De motor stopt tijdens bedrijf.	De motor is oververhit.	Controleer of de machine niet gesmoord is en wacht tot de machine is afgekoeld (ongeveer 30 min).
De machine blaast stof uit.	Het filter is losgeraakt of kapot.	Controleer en vervang indien nodig.
Abnormaal geluid van de machine.		Laat nakijken..

## EG-verklaring

Hierbij verklaren wij dat de DC 1800 H, Autostart & XL voldoet aan de volgende voorschriften en normen:

2006/42/EC, 2014/30/EU, 2014/35/EU, EN 60204-1:2018, EN1822-1:2019.

Dustcontrol AB



**Nina Uggowitzer / CEO & Technical Manager**

**2024-10-18**

## Reserveonderdelen

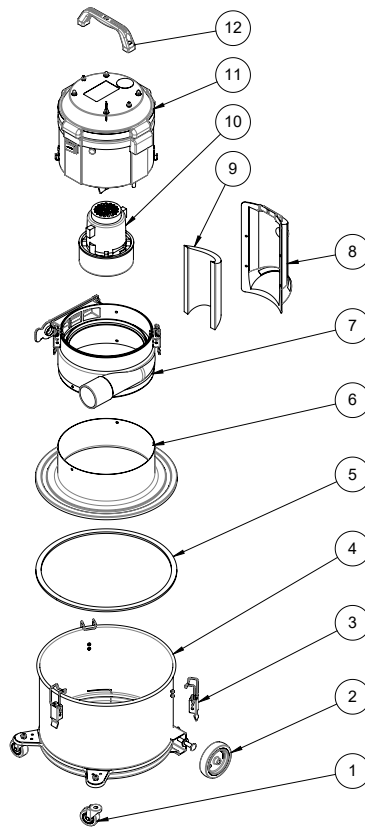

Nummer	Art. nr.	Naam
1	42308	Verbindingswiel D50 H64
2	42307	Wiel D100
3	42365	Excentrische vergrendeling
4*	42278-40	Houder
	40444-1	ContainerXL
5	40514	Pakking 15x8 Zelfklevend
6	42276	Cycloon/Cap
7	940453-70	Inlaatmodule
8	42275	Uitlaatkanaal
9	42284	Geluid absorberend
10	41800	Motorpakket Eco 1285W
	41801	Motorpakket Auto Eco 1285W
11	41801-70	Motorpak, DC Auto Eco 1285W
12	426700	Hendel

# Contact

## Dustcontrol Worldwide



**AT**  
Dustcontrol Ges.m.b.H.  
info@dustcontrol.at  
www.dustcontrol.at



**AU**  
All Preparation Equipment  
www.allprep.com.au



**BENELUX**  
Dust Solutions BV  
www.dustsolutions.nl



**BG**  
Metaltech14 Ltd.  
metaltech14@abv.bg  
www.dustcontrolbg.com



**CA** Dustcontrol  
Canada Inc.  
info@dustcontrol.ca  
www.dustcontrol.ca



**CH**  
Rosset Technik Maschinen  
Werkzeuge AG  
info@rosset-technik.ch  
www.rosset-technik.ch



**CL**  
Beckart Tecnologia Ambiental S.A.  
ambitec@ambitec.cl  
www.ambitec.cl



**CN**  
Suzhou Dustcollect Filtration  
Technology Co. Ltd.  
wang@dustcollect.cn  
www.dustcollect.cn



**CZ / SK** Ener  
Group CZ, S.R.O. Infolinka:  
+420 602 795 800  
info@energrou.cz  
www.prumysloveodsavani.cz/



**DE**  
Dustcontrol GmbH  
info@dustcontrol.de  
www.dustcontrol.de



**DK**  
Construction – Erenfred Pedersen A/S  
info@ep.dk  
www.ep.dk  
  
Industry – Dansk Procesventilation ApS  
info@dansk-procesventilation.dk  
www.dansk-procesventilation.dk



**EE**  
G-Color Baltic OÜ  
sales@g-color.ee  
www.g-color.ee



**ES**  
Barin, s.a.  
info@barin.es  
www.barin.es



**GB**  
Dustcontrol UK Ltd.  
sales@dustcontrol.co.uk  
www.dustcontrol.co.uk



**GR**  
Mavrogiannakis S.A  
ekttox@enternet.gr  
www.ekttoxefis.com.gr



**FI**  
Dustcontrol FIN OY  
dc@dustcontrol.fi  
www.dustcontrol.fi



**FR**  
Construction – SMH Equipements  
info@abequipements.com  
www.smhequipements.com



Industry – Dustcontrol AB  
info@dustcontrol.fra  
www.dustcontrol.fra



**HR**  
Kermek d.o.o.  
kruno.nedeljko@kermek.com  
www.kermek.com



**HU**  
Vandras Kft  
vandras@t-online.hu  
www.vandras.hu



**IN**  
Advance Ventilation Pve Ltd.  
sales@advanceventilation.com  
www.advanceventilation.com



**IT**  
Airum srl  
info@airum.com  
www.airum.com



**KR**  
ESH Engineering Co.  
eshengco@gmail.com  
www.eshengco.com



**LT**  
UAB Hidromega  
info@hidromega.lt  
www.hidromega.lt



**LV**  
SIA Reaktivs  
reaktivs@reaktivs.lv  
www.reaktivs.lv



**MY, ID**  
Stada EnviroSpace Bhd  
info@stada.com.my  
www.stada.com.my



**NO**  
Teijo Norge A.S  
firmapost@teijo.no  
www.teijo.no



**NZ**  
Artizan Diamond Tools  
enquiry@artizandiamond.co.nz  
www.artizandiamond.co.nz



**PE**  
Efixo  
contacto@efixo.pe  
www.efixo.pe



**PH**  
Sweden Concrete Machines Inc.  
peringe@packoskick.se  
www.swedenconcretemachines.ph



**PL**  
Bart Sp. z o.o.  
info@bart-vent.pl  
www.bart-vent.pl



**PT**  
Metec-Mecano Técnica, Lda.  
geral@metec.pt  
www.metec.pt



**RO**  
AWS Elektrotehnik  
office@awstehnik.ro  
www.awstehnik.ro

General Contractor Industry SRL  
office@gci-grup.ro  
www.gci-grup.ro



**RS**  
Enel Alati  
eneldoo@eunet.rs  
www.eneldoo.rs



**RU**  
Centre Vacuum System  
panov.g@movers-td.com  
www.dustcontrolrus.ru



**SE**  
Dustcontrol AB  
info@dustcontrol.se  
www.dustcontrol.com



**SG**  
Stada EnviroSpace Pte Ltd  
Info@stada.com.my  
www.stada.com.my



**TW**  
Goodland Enterprise Co., Ltd.  
sales@goodland.com.tw  
www.goodland.com.tw



**TH**  
MCON Intertrade Co., Ltd.  
sales@mconintertrade.com  
www.mconintertrade.com



**TR** Ventek  
Mühendislik Ltd.  
info@ventek.com.tr  
www.ventek.com.tr



**AE**  
Global Enterprises Trading Co L.L.C.  
sales@globalentco.com  
www.globalentco.com



**GEM**  
Industrial Equipment Trading Co. Tel:  
+971 4 8840 474  
Email: gemuae@eim.ae



**UA**  
MBK Obshemashkontrakt, JSC  
zao@omk.dp.ua  
www.omk.dp.ua



**US**  
Dustcontrol Inc.  
info@dustcontrolusa.com  
www.dustcontrol.us



**VN**  
Tayhostar JSC  
tayhostar@tayhostar.vn  
www.tayhostar.vn

Please contact the head office  
in Sweden if you do not find a  
distributor in your area.  
info@dustcontrol.se